

PILAT & PILAT

PRICES 2024/2025 International

EXCL. VAT

content

- 1 PRODUCT INFORMATION
- 7 TABLES
- 33 COFFEE TABLES & SMALL TABLES
- 45 DESKS
- 51 BENCHES
- 67 ARMCHAIRS & CHAIRS
- 77 CABINETS, SIDEBOARDS & SHELVING UNITS

WWW.PILAT.NL

PRODUCTION PROCES

OWN MANUFACTURING PLANT IN BOSNIA

All furniture and wooden home accessories from Pilat&Pilat are produced at Nordent. They have their own manufacturing plant in Bosnia Herzegovina, employing some 60 craftspeople on a full-time basis. Pilat&Pilat like to buy their wood privately from small-scale operators. For many generations, orchards have been a sustainable source of income for the elderly in the woody regions of Bosnia. On average, families have about two hectares of woodland with dozens of fruit trees, such as walnut and cherry trees. After many years of harvesting the fruits, the trees are finally given the chop. Three trees will get a family, often consisting of three generations, comfortably through winter. The younger generation always takes care of new plantings and the maintenance of the orchard. A personal hallmark of care and dedication is automatically passed on to the growing wood from one generation to the next.

FROM FAMILY ORCHARD TO 'FAMYLJE' COLLECTION. A SUSTAINABLE AND SENSIBLE PROCESS.

SUSTAINABLE WOOD SELECTION

The solid wooden furniture of the 'Famylje' Collection revolves around three types of wood: oak, light elm and walnut. The unique character of the tree is retained in each piece of furniture. In terms of appearance, no two pieces of the same type of furniture are exactly identical, because of a different shade, for instance.

For the Famylje Collection, a furniture maker will endeavour to create the best possible balance by choosing the right wood. A customer with special requirements with regard to the preferred furniture wood is advised to first talk to his dealer. In many cases, it would be desirable to match the appearance of new furniture to the customer's preference. Colour and structure are variables for the customer to choose from. The furniture maker will do his best to meet the customer's choice. However, this may result in an extra charge. As was pointed out, the procedure of purchasing wood in Bosnia is quite different from the methods followed by Dutch furniture manufacturers, who buy their wood from wholesalers. We buy a certain quality of wood as required, at a price to match. Pilat&Pilat and Nordent take responsibility for the environment by using the large pieces of high-quality wood for making furniture. Smaller pieces, left over after selecting and manufacturing furniture, are used for the production of home accessories. Any remaining wood is used for heating the dry kilns and the furniture plant. In this process, native trees from wooded Bosnia are being used in a sustainable manner.

TAILORED TO SUIT INDIVIDUAL REQUIREMENTS

The furniture quality is continuously monitored during the entire production process. Each piece of furniture is custom-made of the type of wood chosen by the customer. Please contact us for a price of nonstandard items. In addition to deviating sizes, alternative tabletop patterns and details such as a bevel or a rounding of the table top are possible.

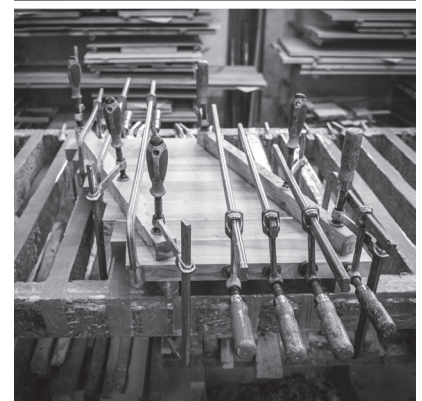

FINISH OPPORTUNITIES OF SOLID WOOD

THREE WOOD TYPES CENTRAL

The solid wooden furniture of the Pilat&Pilat Famylje Collection revolves around three types of wood; oak, walnut and light elm. The unique character of the tree is retained in each piece of furniture. That is the reason why no two pieces of furniture are exactly identical, but will differ in things like colour shade. The wood is selected and processed by experienced furniture makers in our own factory in Bosnia. Our furniture quality is continuously monitored during the entire production process. Each piece of furniture is custom-made of the type of wood chosen by the customer. The wood is finished using natural oil, furniture soap or a laquer.

BEECH WOOD

From January 2023 we now also offer the wood type beech for a selected number of collection models. Beech wood has an even structure with little drawing and wide plank parts are possible. This gives a beech wood piece of furniture a calm, light appearance.

WOODEN SAMPLE BOX

The solid wooden furniture have several possible finishes. Depending on the appearance and maintenance, a finish that suits the user can be chosen. The furniture can be finished with natural oil and / or soap, which gives the wood a soft, natural look. Furthermore, a lacquer, possibly in combination with a stain or paint finish can be chosen. The sample material provides insight into the options available.

MATERIAL SAMPLES AND FINISHES

An overview of the wood samples and finishes can be found on our website www.pilat.nl. At the bottom of the footer, click on 'Wood samples and finishes' for an overview of the wood samples with the various finishes and the basic colors that we use for coated steel. This also applies to the standard colors of sheep leather and cow leather that we offer.



PROPERTIES OF SOLID WOOD

WOOD IS A PRODUCT OF NATURE

Due to the natural nature, the color and structure of the furniture are never identical. In spite of the treatment, the colour of the wood may change over time due to influences of sunlight and artificial light. Wood has an open structure. As a result, exposure to humidity in the air may have an effect on the furniture. Changes may occur at any time. Particularly during winter months when heaters are turned on full power, the air may become too dry for the wood.

To minimise the risk of warping of the wood, we suggest a healthy indoor climate with a room temperature of approx. 20 degrees Celsius and a relative air humidity of around 50% - 60%. Dry air may cause minute cracks in the wood, which will close again as the humidity level goes up. A natural product such as wood can shrink and expand. This is kept to a minimum with a constant relative humidity of around 50%. This prevents cracks in your wooden furniture. If you have already discovered cracks in your wooden furniture, maintain your furniture extra and wait for the period of freezing cold to end.

Usually the cracks disappear by themselves when the humidity is back to normal.

WOOD IS A HIGH-GRADE MATERIAL

Wood needs to be treated with care. Sharp, hot or wet objects may damage the wooden surface. Spilt liquids should be removed immediately to prevent stains. The use of caustic - and certainly abrasive - cleaning agents is not recommended. Many stains can be prevented by using coasters and by shorten the exposure time of the stain by removing it in time. With the correct maintenance of oiled and soaped furniture you can avoid that stains can penetrate the wood.

SMALL DO-IT-YOURSELF REPAIRS

The advantage of unpainted and not artificially coloured solid furniture is to have the routine maintenance and small repairs in your own hands. Permanent and serious stains, such as traces of regular touching or rubber shoes on table legs, can be removed using fine (400-grit) sandpaper. Make sure you sand lengthwise in the direction of the wood grain. This will remove the film of oil or soap that had been put on for protection. Remember to re-apply the surface protection after treatment. A deep scratch or dent may be repaired through sanding or swelling (briefly pressing a hot iron onto a moist cloth on the damaged spot). In that way it will be a breeze to repair small damage to your furniture without expert knowledge.

IN A NUTSHELL:

- Prevent discoloration by keeping your furniture away from permanent sunlight.
- Keep some distance between your furniture and the heat source (heater or heat pump), to prevent the wood from drying out.
- Get yourself a hygrometer and keep the relative air humidity indoors between 50% and 60%.
- Use coasters or placemats to prevent rings from cups and glasses.
- Be careful with porous vases and flower pots, these can leave irreparable circles behind.

WHEN WINTER COMES

To prevent cracks in your furniture in winter due to a dry indoor climate, you can do the following:

- Place a humidifier.
- Maintain your furniture with soap (or oil) more often
- Ventilate your house sufficiently.

MAINTENANCE WITH OIL



Use a moist cloth for everyday cleaning of the furniture.

Maintenance with oil is carried out every six months or annually, depending on use.

When using the white-pigmented maintenance oil, remember to shake the bottle (and possibly stir the fluid) to ensure the white pigment and the oil are mixed well.

Apply a small amount of maintenance oil to a cotton cloth and rub into the wood.

Allow drying for 20 minutes: rub the furniture dry with a clean cotton cloth in the direction of the wood grain. Repeat the treatment after approx. 40 minutes.

The furniture may only be used normally after 4 hours. After treatment with maintenance oil, the wood on the treated areas should not come into contact with water for 24 hours to allow the undisturbed curing process. Use coasters during this time.

Warning:

after use, remember to rinse the cotton cloth that has been used to rub in the maintenance oil and let it dry in the open air. Alternatively, dip the cloth into water, put it into a plastic bag and throw it away. That is to avoid the risk of spontaneous combustion.

Maintenance products such as soap and oil can be ordered at your dealer or via an email to pilat@pilat.nl.

- | | | |
|---------------------------------|--------|----------|
| • bottle of natural oil | 250 ml | € 11,50* |
| • bottle of white pigmented oil | 250 ml | € 11,50* |
| • bottle of brown oil | 250 ml | € 11,50* |
| • bottle of black oil | 250 ml | € 11,50* |

* excluding shipping, prices may vary by country

The natural oils used for Pilat&Pilat furniture enhance the structure and the colour of the wood and create a strong and abrasion-proof surface. The special composition of the oil ensures the "breathing" ability of the wood. That is the reason why the wood is resilient and durable, while it retains its natural properties.

By using the furniture, the oil layer can become worn. In that case you may wish to bring the furniture 'back to life' using the maintenance oil supplied (natural or white-pigmented). The maintenance oil repairs the original film of oil and gives a silky, resilient and dirt and water resistant layer.

Content maintenance box:

- 250 ml maintenance oil (white pigmented, natural or brown)
- polishing cloth
- plastic bag
- sandpaper
- maintenance recommendation

IMPORTANT:

Pilat&Pilat-Furniture treated with oil will require an 8 to 10 - week curing period. In this time, the wood will be covered with a protective layer. We advise against the intensive use of the furniture in this period.

• Do NOT treat your furniture with maintenance oil for the first 8 - 10 weeks.

• Protect your oiled furniture against moisture by using coasters.

MAINTENANCE WITH SOAP



Normal maintenance

Put 1 part soap in a jar or bottle and add 10 parts water to it. Apply the mixture to a clean, damp microfibre cloth and rub the furniture in the direction of the wood grain. Leave for 2 minutes and then wipe the furniture with a slightly damp cloth.

The maintenance with soap should be repeated, depending on the usage and to what extent the furniture is dirty:

- **dining and coffee tables:** once every 1 to 3 weeks (clean regularly along the legs of your furniture too, to avoid colour differences)
- **dressers and closets:** once every 1 to 3 months

Before using a mixture of white pigmented soap, stir or shake the mixture well to mix the white pigment with soap.

It is advisable to keep this mixture in a closable bottle or spray bottle, ready for use.

Apply the mixture with a cloth (dish cloth or microfibre cloth) and soap the whole piece of furniture in the direction of the woodgrain. Let it soak for about 2 minutes.

Then wipe the furniture with a clean, damp cloth removing excess soap and dirt. The water will evaporate very rapidly, leaving a new layer of soap in the wood.

It can occur, especially in oak, that the wood fibers open after the first maintenance with soap. The furniture then feels rough. In the maintenance box you will find a piece of sandpaper 400. Then sand, in the length of the wood grain, the surface soft again.

Maintenance products such as soap and oil can be ordered at your dealer or via an email to pilat@pilat.nl.

- bottle of natural soap 250 ml € 11,50*
- bottle of white pigmented soap 250 ml € 11,50*

FOR PERSISTENT STAINS

- Super stain remover 250 ml € 18.95*
- Stain spray (oak) 250 ml € 19.95*

* excluding shipping, prices may vary by country

Soap as a maintenance agent for wooden furniture works in two ways. Firstly, soap acts preventively. After each soap treatment, a saturation of the surface by the coconut and soy grease follows, disallowing dirt and moisture are to penetrate into the wood. Secondly, the soap also works as a cleaning agent by removing the dirt in the upper layer of the wood. When a soaped furniture is delivered to you, it is pre-treated with an extra protective layer and then soaped several times. It is recommended to maintain the furniture regularly with soap.

The soap (white pigmented or natural) is manufactured from raw plant materials without the use of colors, fragrances, preservatives or other artificial additives.

The soap is highly concentrated and has to be diluted with water prior to application to the wood (1 part soap to 10 parts water). The higher the concentration of soap, the whiter / paler the wood becomes or remains. As you apply the soap more often, the wood will become or remain more white or pale. The wood is therefore better protected.

Maintenance for dirt and stains

Apply the diluted soap to the rough side of a scouring pad. Then sand the stain with light pressure in the direction of the wood grain. Then wipe the area with a clean, damp cloth. Repeat this for stubborn stains. The furniture should dry between treatments. Then soap the furniture according to normal instructions with a damp cloth.

Difficult stains, such as greasiness and red wine, can be removed by applying a small amount of diluted soap to the stain and covering it with a damp cloth and allowing the soap to work for about 10-12 hours. Then soap the surface again.

Content maintenance box:

- bottle of 250ml maintenance soap (white or natural)
- scourer
- sandpaper
- maintenance instructions

MAINTENANCE OF LACQUERED SURFACES

In addition to the treatment with oil and soap, Pilat&Pilat offers a lacquer finish. A transparent lacquer can be combined with a stain. Furthermore, oak can be sprayed in a color lacquer, whereby the structure of the wood remains visible. In addition to the standard color lacquers, a lacquer finish is possible in almost any RAL or Sikkens color.

A lacquer closes the wood in such a way that air humidity differences have less influence on the operation of the wood. Furthermore, lacquering is practical: the furniture can easily be removed with a duster or slightly damp cloth (not too wet). Do not use in the treatment of stains abrasives, only mild soapy water.

Important: do not let liquids lie down but remove within 10 to 15 minutes. Use coasters and do not put any hot objects on the furniture, this will give stains that can not be removed.

Be careful with porous vases and flower pots, these can leave irreparable circles. Under glass with cool drinks, condensation can form under the bottom. That is why it is good to use coasters.

A lacquered furniture feels different than a furniture with oil or soap finish. Due to the paint the contact with the wood disappears for the user. Any damage is more difficult to solve. Where in a soap or oil finish a piece of furniture can be updated without visible traces, a lacquered piece of furniture will often have to be completely sanded and re-sprayed.

TABLES

prices 2024 in euro excl. VAT

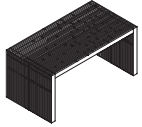

BAS
page 8

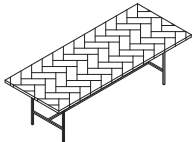

BRUGT
page 9



DIRK-JISK
RECTANGULAR/
SQUARE
page 10



DIRK-JISK
OVAL/ROUND
page 11

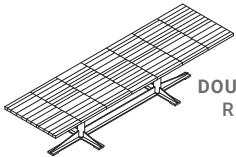

DIRK-JISK
DOUBLE SUPPORT
RECTANGULAR
page 12

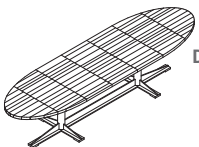

DIRK-JISK
DOUBLE SUPPORT
OVAL WITH
STRAIGHT SIDES
page 13



DJURRE
page 14



DJURRE
page 15

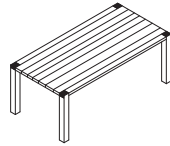

DORUS
page 16



ELIZABETH
page 17

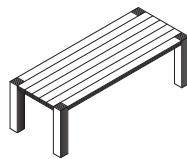

HINDRIK
LANGSHOUT
page 18

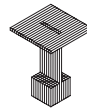

JEHANNES
page 19

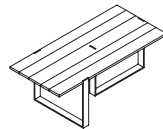

KLAAS
page 20

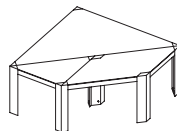

KODAMA
page 21-23

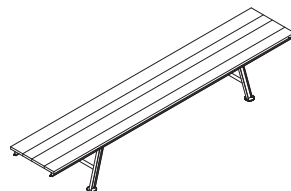

MADS
page 24

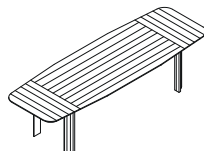

OVE
page 25

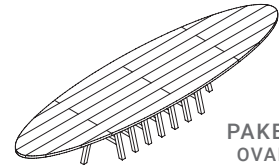

PAKE SYTSE
OVAL/ROUND
page 26

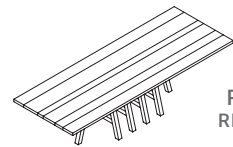

PAKE SYTSE
RECTANGULAR
page 27

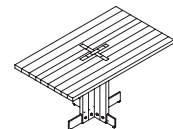

STIEN
page 28

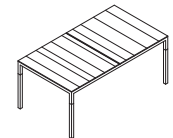

TIEMEN I
page 29

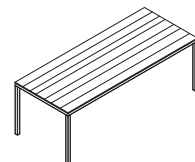

TIEMEN II
page 30

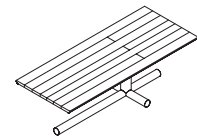

TOM
page 31

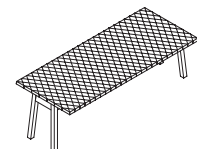

WYBE
page 32

BAS table

design Gjalt Pilat, 2001

prices 2024 in euro excl. VAT

custom sizes on request

dimensions

L x W x H

light elm

oak

walnut

key features / additional prices

Bas sidetable

160 x 42 x 76

1.662

1.828

2.011

- made of 6,8 cm thick wood

180 x 42 x 76

1.694

1.863

2.050

- composed of various lengths from 40 to 100 cm

200 x 42 x 76

1.724

1.897

2.086

- dining table is delivered in two parts

220 x 42 x 76

1.756

1.931

2.124

- The finishing options are according to the solid wood samples such as

240 x 42 x 76

1.787

1.966

2.162

- presented in the current sample box.

Bas dining table

160 x 84,5 x 76

3.325

3.658

4.024

- The prices are the same for all finishes;

180 x 84,5 x 76

3.386

3.725

4.097

- soap, oil, stain-lacquer, transparant

200 x 84,5 x 76

3.448

3.792

4.172

- lacquer and color lacquer.

220 x 84,5 x 76

3.510

3.861

4.247

240 x 84,5 x 76

3.572

3.929

4.322

160 x 100,5 x 76

3.723

4.095

4.505

180 x 100,5 x 76

3.793

4.172

4.589

200 x 100,5 x 76

3.862

4.248

4.673

220 x 100,5 x 76

3.930

4.323

4.756

240 x 100,5 x 76

4.001

4.401

4.841

BRUGT table

design Gjalt Pilat, 2019

prices 2024 in euro excl. VAT

custom sizes on request

dimensions

L x W x H

light elm

oak

walnut

key features / additional prices

Brugt table

180 x 100 x 76

3.075

3.382

3.536

herringbone
pattern

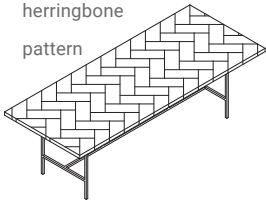

200 x 100 x 76

3.163

3.479

3.637

220 x 100 x 76

3.350

3.685

3.853

240 x 100 x 76

3.574

3.931

4.110

260 x 100 x 76

3.748

4.123

4.310

280 x 100 x 76

3.932

4.325

4.522

300 x 100 x 76

4.199

4.618

4.828

Brugt table

180 x 100 x 76

2.388

2.627

2.747

full lengths

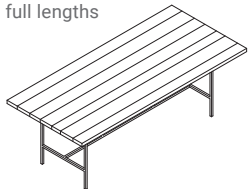

200 x 100 x 76

2.487

2.735

2.860

220 x 100 x 76

2.666

2.932

3.065

240 x 100 x 76

2.840

3.124

3.266

260 x 100 x 76

3.023

3.325

280 x 100 x 76

3.156

3.472

300 x 100 x 76

3.315

3.646

Brugt table

260 x 100 x 76

3.477

several lengths

280 x 100 x 76

3.630

300 x 100 x 76

3.812

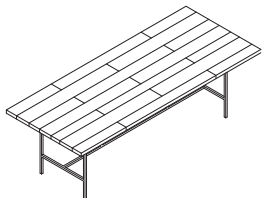

- standard table top herringbone pattern
- table top thickness is 4 cm
- The table top has an overhang of 25 cm on the short side
- Frame solid steel 2 x 2 cm
- Frame with coating in the standard colors RAL 9004 (black), RAL 9010 (white), Sikkens C4.40.30 (red), F6.05.50 (taupe) or E4.40.40 (caramel). Alternative colors are available on request
- supplied with glides and felts
- Space between the legs at:
 - table length 180: seat space 126
 - table length 200: seat space 146
 - table length 220: seat space 166
 - table length 240: seat space 186
 - table length 260: seat space 206
 - table length 280: seat space 226
 - table length 300: seat space 246
- finishing possibilities according to the solid wood samples as presented in a current sample box
- The prices are the same for all finishes; soap, oil, stain-lacquer, transparent lacquer and color lacquer.
- in oak the tabletop is possible in a rustic version; cracks in the tabletop and open knots are filled with black coloured filler. This option does not affect the price.
- From 260 Brugt full length (walnut) is composed of several lengths
- combines well with the Marjelle sofa

DIRK JISK table ONE LEG | RECTANGULAR, SQUARE

design Gjalt Pilat, 2009

prices 2024 in euro excl. VAT

custom sizes on request

dimensions

L x W x H

light elm

oak

walnut

key features / additional prices

Dirk Jisk table rectangular
frame for 200/220 cm

200 x 90 x 76

3.199

3.519

3.679

200 x 100 x 76

3.323

3.655

3.821

220 x 90 x 76

3.271

3.598

3.761

220 x 100 x 76

3.400

3.740

3.910

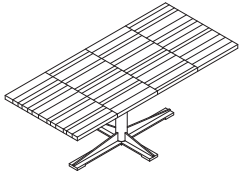

Dirk Jisk table rectangular
frame for 240/260 cm

240 x 90 x 76

3.340

3.674

3.842

240 x 100 x 76

3.480

3.828

4.002

260 x 90 x 76

3.416

3.758

3.929

260 x 100 x 76

3.568

3.925

4.104

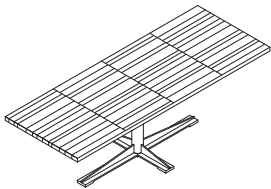

Dirk Jisk square

130 x 130 x 76

3.188

3.506

3.666

140 x 140 x 76

3.333

3.667

3.833

150 x 150 x 76

3.479

3.827

4.001



- thickness of table top is 4 cm
- frame and table top dismountable
- Dirk Jisk table tops (on a single leg) come standard with two sizes of frames, depending on the length of the table
- Frame with coating in the standard colors RAL 9004 (black), RAL 9010 (white), Sikkens C4.40.30 (red), F6.05.50 (taupe) or E4.40.40 (caramel). Alternative colors are available on request
- each table top is divided in 4 equal parts in the longitudinal direction
- The finishing options are according to the solid wood samples such as presented in the current sample box.
- The prices are the same for all finishes; soap, oil, stain-lacquer, transparent lacquer and color lacquer.
- maximum length is 260 cm
- **option for table top**
tabletop composed of full lengths and varying widths as shown below. Up to 260 cm the price is equal to standard version of the Dirk Jisk table.

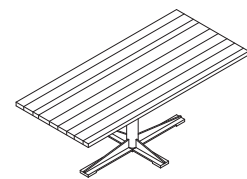



DIRK JISK table ONE LEG | OVAL, ROUND

design Gjalt Pilat, 2009

prices 2024 in euro excl. VAT

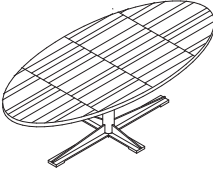
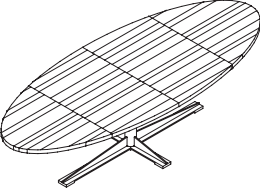
custom sizes on request

dimensions	L x W x H	light elm	oak	walnut
Dirk Jisk table oval frame for 200/220 cm	200 x 90 x 76 220 x 100 x 76	3.393 3.534	3.733 3.888	3.902 4.065
				
Dirk Jisk table oval frame for 240/260 cm	240 x 110 x 76 260 x 110 x 76	3.694 3.877	4.064 4.264	4.249 4.458
				
Dirk Jisk table oval frame for 280/300 cm	280 x 110 x 76 300 x 120 x 76	4.182 4.733	4.600 5.206	* 4.809 * 5.443
				
Dirk Jisk round	Ø 130 x 76 Ø 145 x 76 Ø 160 x 76	3.323 3.475 3.646	3.655 3.822 4.011	3.821 3.996 4.193
				

key features / additional prices

- thickness of table top is 4 cm
- frame and table top dismountable
- Dirk Jisk table tops (on a single leg) come standard with two sizes of frames, depending on the length of the table
- Frame with coating in the standard colors RAL 9004 (black), RAL 9010 (white), Sikkens C4.40.30 (red), F6.05.50 (taupe) or E4.40.40 (caramel). Alternative colors are available on request
- each table top is divided in 4 equal parts in the longitudinal direction
- The finishing options are according to the solid wood samples such as presented in the current sample box.
- The prices are the same for all finishes; soap, oil, stain-lacquer, transparent lacquer and color lacquer.
- maximum length is 300 cm
- **option for table top**
tabletop composed of full lengths and varying widths as shown below.
Up to 260 cm the price is equal to standard version of the Dirk Jisk table.
- Prices indicated with * Walnut 280 and 300 are not possible in full lengths.

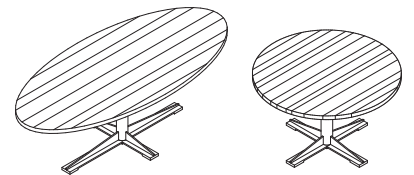

- table top rejuvenation possible, 2 options:
facet or rounding, please indicate when ordering. Additional price 5%



DIRK JISK table DOUBLE SUPPORT | RECTANGULAR

design Gjalt Pilat, 2020

prices 2024 in euro excl. VAT

custom sizes on request

dimensions

L x W x H

light elm

oak

walnut

key features / additional prices

Dirk Jisk table rectangular
double support

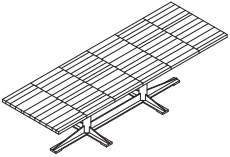

300 x 100 x 76

4.954

5.449

5.697

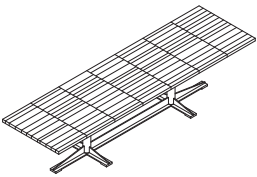

350 x 100 x 76

5.394

5.933

6.203

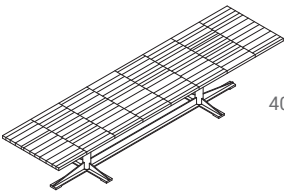

400 x 100 x 76

5.822

6.404

6.695

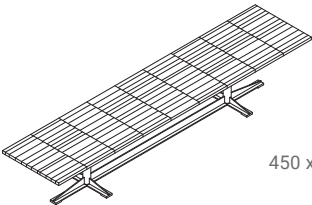

450 x 100 x 76

6.204

6.825

7.135

- thickness of table top is 4 cm
- the table top consists of parts of 50 cm
- extra options table top composition:
with extra wide parts, extra charge 10%
- Table top compositions based on whole lengths are not possible
- Frame and table top are supplied separately
- each length has a unique frame size as shown below
- Frame with coating in the standard colors RAL 9004 (black), RAL 9010 (white), Sikkens C4.40.30 (red), F6.05.50 (taupe) or E4.40.40 (caramel). Alternative colors are available on request
- The finishing options are according to the solid wood samples such as presented in the current sample box.
- The prices are the same for all finishes; soap, oil, stain-lacquer, transparent lacquer and color lacquer.

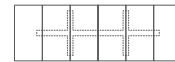

DIRK JISK table DOUBLE SUPPORT | OVAL WITH STRAIGHT SIDES

design Gjalt Pilat, 2020

prices 2024 in euro excl. VAT

custom sizes on request

dimensions

L x W x H

light elm

oak

walnut

key features / additional prices

Dirk Jisk table oval with straight sides
double support

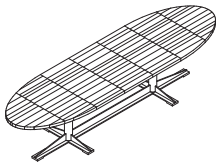

350 x 100 x 76

5.763

6.339

6.627

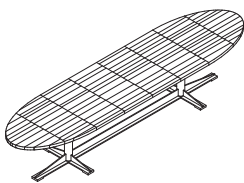

400 x 100 x 76

6.213

6.835

7.145

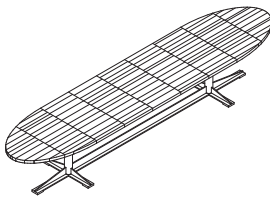

450 x 100 x 76

6.664

7.330

7.663

- thickness of table top is 4 cm
- the table top consists of parts of 50 cm
- extra options table top composition: with extra wide parts, extra charge 10%
- Table top compositions based on whole lengths are not possible
- Frame and table top are supplied separately
- each length has a unique frame size as shown below
- Frame with coating in the standard colors RAL 9004 (black), RAL 9010 (white), Sikkens C4.40.30 (red), F6.05.50 (taupe) or E4.40.40 (caramel). Alternative colors are available on request
- The finishing options are according to the solid wood samples such as presented in the current sample box.
- The prices are the same for all finishes; soap, oil, stain-lacquer, transparent lacquer and color lacquer.
- option for table top table top rejuvenation possible, 2 options: facet or rounding, please indicate when ordering. Additional price 5%

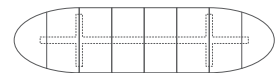
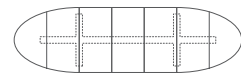
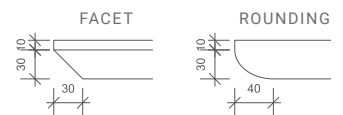

DJURRE table type 1

design Gjalt Pilat, 2023

prices 2024 in euro excl. VAT

custom sizes on request

dimensions

L x W x H

Djurre rectangular

220 x 100 x 76
240 x 100 x 76
260 x 100 x 76
280 x 100 x 76
300 x 100 x 76



Djurre straight oval

220 x 100 x 76
240 x 100 x 76
260 x 110 x 76
280 x 110 x 76
300 x 110 x 76
320 x 110 x 76
340 x 110 x 76



Djurre oval
full lengths

220 x 100 x 76
240 x 110 x 76
260 x 110 x 76
280 x 110 x 76
300 x 120 x 76
320 x 120 x 76
340 x 120 x 76

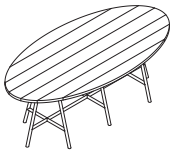

Djurre oval
several lengths

220 x 100 x 76
240 x 110 x 76
260 x 110 x 76
280 x 110 x 76
300 x 120 x 76
320 x 120 x 76
340 x 120 x 76

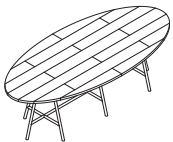

table length	number of legs	space between legs in cm
220	8	57
240	8	62
260	8	72
280	10	53,7
300	10	60,3
320	10	67
340	10	73

beech

light elm

oak

walnut

3.757
3.872
3.995
4.355
4.521

4.133
4.260
4.394
4.791
4.973

4.321
4.453
4.594
5.008
5.199

3.743
3.832
4.165
4.593
4.885
5.242
5.466

4.117
4.215
4.581
5.052
5.374
5.766
6.013

4.304
4.407
4.789
5.282
5.618
6.028
6.286

3.584
3.736
3.901
4.305
4.593
* 4.907
* 5.076

3.942
4.109
4.291

4.121
4.296

4.907
5.076

4.735
5.052
5.397
5.584

4.486
4.951
5.282
5.643
5.838

key features / additional prices

- table top thickness 3 cm
- 3 table top shapes possible: 1. rectangular with profiled edges ^A) + composition from whole lengths, transverse to the direction of the table 2. straight-oval with rounded sides composed of several lengths ^B) and 3. oval with full lengths table top composition ^C)
- * Djurre oval: table top composition, light elm from length 320 with several lengths. Beech is possible with whole lengths up to and including 340 cm
- the frame is constructed from steel pipes with a diameter of 3 cm
- Djurre type 1 has an adapted frame per length: see table at bottom left
- base with coating in the standard colors RAL 9004 (black), RAL 9010 (white), Sikken C4.40.30 (red), F6.05.50 (taupe) or E4.40.40 (caramel). Alternative colors are possible on request
- The finishing options are according to the solid wood samples such as presented in the current sample box.
- The prices are the same for all finishes; soap, oil, stain-lacquer, transparent lacquer and color lacquer.

- ^A) side view rectangular table top: 3 cm thick table top with profiled edges:

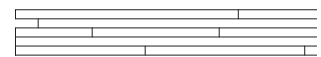

- ^B) side view rounding straight-oval:



- ^C) side view oval:



PILAT &
PILAT

DJURRE table type 2

design Gjalt Pilat, 2024

prices 2024 in euro excl. VAT

custom sizes on request

dimensions

L x W x H

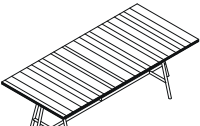
	Djurre rectangular	220 x 100 x 76
		240 x 100 x 76
		260 x 100 x 76
		280 x 100 x 76
		300 x 100 x 76

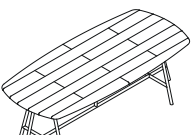
	Djurre straight oval	220 x 100 x 76
		240 x 100 x 76
		260 x 110 x 76
		280 x 110 x 76
		300 x 110 x 76

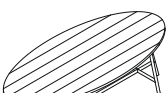
	Djurre oval	220 x 100 x 76
	full lengths	240 x 110 x 76
		260 x 110 x 76
		280 x 110 x 76
		300 x 120 x 76

	Djurre oval	220 x 100 x 76
	several lengths	240 x 110 x 76
		260 x 110 x 76
		280 x 110 x 76
		300 x 120 x 76

table length	number of legs	space between legs in cm
220	6	134
240	6	154
260	6	174
280	6	194
300	6	214

beech

light elm

oak

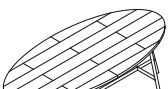
walnut

3.757	4.133	4.321
3.872	4.260	4.453
3.995	4.394	4.594
4.355	4.791	5.008
4.521	4.973	5.199

3.743	4.117	4.304
3.832	4.215	4.407
4.165	4.581	4.789
4.593	5.052	5.282
4.885	5.374	5.618

3.584	3.942	4.121
3.736	4.109	4.296
3.901	4.291	
4.305		
4.593		

		4.486
	4.735	4.951
	5.052	5.282

key features / additional prices

- table top thickness 3 cm
- 3 table top shapes possible: 1. rectangular with profiled edges ^{A)} + composition from whole lengths, transverse to the direction of the table 2. straight-oval with rounded sides composed of several lengths ^{B)} and 3. oval with full lengths table top composition ^{C)}
- Djurre straight-oval and oval type 2 go up to a length of 300cm
- the frame is constructed from steel tubes with a diameter of 3 cm
- Djurre type 2 always has 6 legs
- Djurre type 2 has an adapted frame per length: see table at bottom left
- base with coating in the standard colors RAL 9004 (black), RAL 9010 (white), Sikkens C4.40.30 (red), F6.05.50 (taupe) or E4.40.40 (caramel). Alternative colors are possible on request
- The finishing options are according to the solid wood samples such as presented in the current sample box.
- The prices are the same for all finishes; soap, oil, stain-lacquer, transparent lacquer and color lacquer.

- A) side view rectangular table top:
3 cm thick table top with profiled edges:

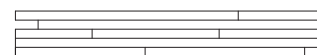

- B) side view rounding straight-oval:



- C) side view oval:

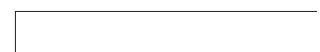

DORUS table

design Gjal't Pilat, 1998

prices 2024 in euro excl. VAT

custom sizes on request

dimensions

L x W x H

Dorus table width 90 cm

140 x 90 x 76

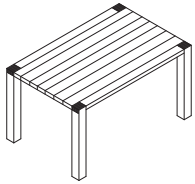

160 x 90 x 76

180 x 90 x 76

200 x 90 x 76

220 x 90 x 76

240 x 90 x 76

Dorus table width

140 x 100 x 76

100 cm

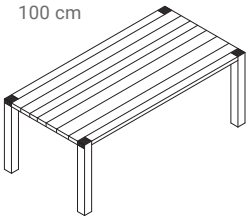

160 x 100 x 76

180 x 100 x 76

200 x 100 x 76

220 x 100 x 76

240 x 100 x 76

light elm

oak

walnut

key features / additional prices

2.237

2.461

2.707

- thickness of table top 4 cm

2.443

2.687

2.956

- the leg of a Dorus table is 8,8 x 8,8 cm

2.568

2.825

3.107

- the legs of a Dorus table are not dismountable

2.680

2.948

3.243

- the table top is assembled of variable widths

2.994

3.293

3.622

- also see: Dorus bench

3.427

3.770

4.147

- The finishing options are according to

2.307

2.538

2.792

- the solid wood samples such as

2.556

2.811

3.092

- presented in the current sample box.

2.680

2.948

3.243

- The prices are the same for all finishes; soap, oil, stain-lacquer, transparent lacquer and color lacquer.

2.789

3.068

3.375

- in oak the tabletop is possible in a rustic version; cracks in the tabletop and open knots are filled with black coloured filler.

3.146

3.461

3.807

This option does not affect the price.

3.584

3.942

4.336

ELIZABETH II table

design Gjalt Pilat, 2016

prices 2024 in euro excl. VAT

custom sizes on request

dimensions

L x W x H

light elm

oak

walnut

key features / additional prices

Elizabeth II table:
3 legs

160 x 100 x 76
180 x 100 x 76
200 x 100 x 76
220 x 100 x 76

2.713
2.796
2.880
2.963

2.984
3.076
3.168
3.260

3.283
3.383
3.485
3.586

- thickness of table top 4 cm
- also see Elizabeth II bench
- the legs measure 6 x 12 cm
- frame/table top dismountable
- from 240 cm on 4 legs
- the table top is made of variable widths and up to 220 cm of full lengths. Longer table tops are built up of 2 or 3 lengths
- The finishing options are according to the solid wood samples such as presented in the current sample box.
- The prices are the same for all finishes; soap, oil, stain-lacquer, transparent lacquer and color lacquer.
- in oak the tabletop is possible in a rustic version; cracks in the tabletop and open knots are filled with black coloured filler. This option does not affect the price.

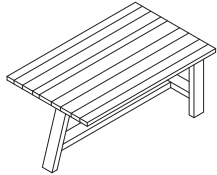

Elizabeth II table
4 legs

240 x 100 x 76
260 x 100 x 76
280 x 100 x 76
300 x 100 x 76
320 x 100 x 76
340 x 100 x 76
360 x 100 x 76

3.535
3.618
3.701
3.786
3.868
3.951
4.034

3.889
3.980
4.071
4.164
4.255
4.346
4.438

4.278
4.378
4.478
4.581
4.680
4.781
4.881



HINDRIK LANGSHOUT table

design Gjalt Pilat, 2004

prices 2024 in euro excl. VAT

custom sizes on request

dimensions

L x W x H

light elm

oak

walnut

key features / additional prices

Hindrik Langshout table

160 x 81 x 76

2.474

2.722

2.994

- the tabletop of the Hindrik Langshout consists of widths of 13.5 cm

180 x 81 x 76

2.682

2.950

3.245

- the legs measure 13,5 x 13,5 cm

200 x 81 x 76

2.889

3.178

3.496

- thickness of the table top is 8 cm

220 x 81 x 76

3.094

3.403

3.743

- from 260 cm the table top is made up of 2 or 3 lengths as shown on the left

240 x 81 x 76

3.300

3.630

3.993

- From 320 cm in length, the table is equipped with demountable legs as standard. The extra price for removable legs is included in the price.

160 x 94,5 x 76

2.725

2.997

3.297

- From 320 cm the table top is 2 cm in the center and 8 cm thick on the sides

180 x 94,5 x 76

2.952

3.248

3.573

- From 320 cm the table top is 2 cm in the center and 8 cm thick on the sides

200 x 94,5 x 76

3.178

3.496

3.845

- extra price for demountable legs for lengths up to 320 cm is 282,- euro

220 x 94,5 x 76

3.403

3.743

4.118

- with the first supplied Hindrik Langshout with removable legs, standard two

240 x 94,5 x 76

3.630

3.993

4.392

- trestles are included as mounting aid, ask for these with your order

Hindrik Langshout table

260 x 81 x 76

3.507

3.857

4.243

- also see: Hindrik Langshout bench

with table top composition

280 x 81 x 76

3.714

4.085

4.494

- the solid wood samples such as

from 260 cm

300 x 81 x 76

3.921

4.314

4.745

- presented in the current sample box.

260 x 94,5 x 76

3.858

4.244

4.668

- The prices are the same for all finishes; soap, oil, stain-lacquer, transparent lacquer and color lacquer.

280 x 94,5 x 76

4.085

4.494

4.943

300 x 94,5 x 76

4.313

4.744

5.219

Hindrik Langshout

320 x 81 x 76

4.629

5.092

5.602

standard demountable

340 x 81 x 76

4.836

5.320

5.851

legs, at no extra charge

360 x 81 x 76

5.043

5.548

6.102

from 320 cm

380 x 81 x 76

5.250

5.775

6.352

400 x 81 x 76

5.458

6.004

6.604

320 x 94,5 x 76

5.092

5.602

6.162

340 x 94,5 x 76

5.319

5.850

6.436

360 x 94,5 x 76

5.547

6.101

6.711

380 x 94,5 x 76

5.775

6.353

6.988

400 x 94,5 x 76

6.002

6.603

7.263

JEHANNES table

design Gjalt Pilat, 2007

prices 2024 in euro excl. VAT

custom sizes on request

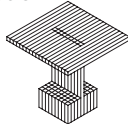
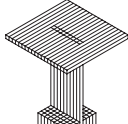
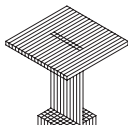
dimensions	L x W x H	light elm	oak	walnut	key features / additional prices
Jehannes table 	60 x 60 x 76	1.435	1.578	1.736	<ul style="list-style-type: none"> • thickness of table top 4 cm • The finishing options are according to the solid wood samples such as presented in the current sample box. • The prices are the same for all finishes; soap, oil, stain-lacquer, transparent lacquer and color lacquer.
	64 x 64 x 76	1.475	1.622	1.785	
	76 x 76 x 76	1.550	1.705	1.875	
Jehannes bar table 	60 x 60 x 104	1.529	1.681	1.850	
	76 x 76 x 104	1.641	1.805	1.986	
Jehannes standing table 	60 x 60 x 110	1.529	1.681	1.850	
	76 x 76 x 110	1.641	1.805	1.986	

KLAAS table

design Trude van Assem, 2008

prices 2024 in euro excl. VAT

custom sizes on request

dimensions

Klaas table

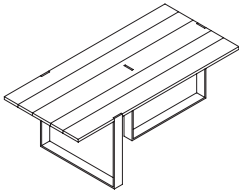

L x W x H

180 x 92 x 76
200 x 92 x 76
220 x 92 x 76
240 x 92 x 76
260 x 92 x 76

beech

light elm

oak

walnut

2.956	3.252
3.051	3.356
3.174	3.492
3.296	3.625
3.402	3.742

key features / additional prices

- thickness of tabletop is 3 cm
- tabletop is composed of full lengths and variable widths
- frame is made of steel size 10 x 1,2 cm
- frame parts and tabletop are dismountable
- in oak the tabletop is possible in a rustic version; cracks in the tabletop and open knots are filled with black coloured filler. This option does not affect the price.
- Frame with coating in the standard colors RAL 9004 (black), RAL 9010 (white), Sikkens C4.40.30 (red), F6.05.50 (taupe) or E4.40.40 (caramel). Alternative colors are available on request
- overhang tabletop of the transversely placed frame part:
 - table length 180 cm : 39 cm
 - table length 200 cm: 51 cm
 - table length 220-260 cm: 60 cm
- also see: Klaas coffeetable
- The finishing options are according to the solid wood samples such as presented in the current sample box.
- The prices are the same for all finishes; soap, oil, stain-lacquer, transparant lacquer and color lacquer.

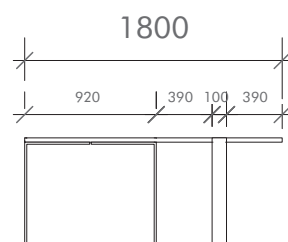

- Dimensions of gaps at length from 180 cm (in mm's):



KODAMA table serie

design Bart Vos, 2022

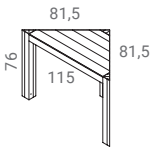
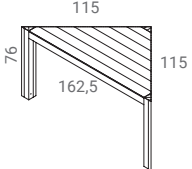
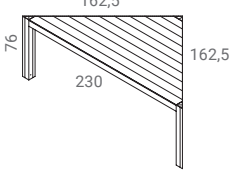
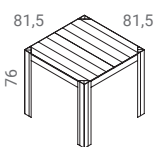
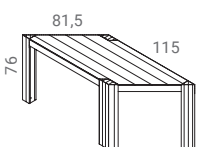
prices 2024 in euro excl. VAT

		beechn			key features / additional prices								
dimensions	L x W x H	light elm	oak	walnut									
<i>geen maatwerk mogelijk</i>													
Kodama 1					<ul style="list-style-type: none"> • thickness of table top is 4 cm • dismountable legs; table top and legs are supplied separately • legs are adjustable • note: the parallelogram cannot be executed in mirror image • Due to the dimensions, a combination of tables is possible • tables can be linked with optional clamps • required number of clamps on a length of: <table border="0" style="margin-left: 20px;"> <tr> <td>81.5 cm</td> <td>1 clamp</td> </tr> <tr> <td>115 cm</td> <td>1 clamp</td> </tr> <tr> <td>162.5 cm</td> <td>2 clamps</td> </tr> <tr> <td>260 cm</td> <td>2 clamps</td> </tr> </table> • possible in oak, light elm and walnut • The finishing options are according to the solid wood samples such as presented in the current sample box. • The prices are the same for all finishes; soap, oil, stain-lacquer, transparant lacquer and color lacquer. 	81.5 cm	1 clamp	115 cm	1 clamp	162.5 cm	2 clamps	260 cm	2 clamps
81.5 cm	1 clamp												
115 cm	1 clamp												
162.5 cm	2 clamps												
260 cm	2 clamps												
	115 x 57,5 x 76	1.154	1.269	1.396									
Kodama 2													
	162,5 x 81,5 x 76	1.567	1.724	1.896									
Kodama 3													
	230 x 115 x 76	2.082	2.290	2.519									
Kodama 4													
	81,5 x 81,5 x 76	1.289	1.418	1.560									
Kodama 5													
	172,5 x 57,5 x 76	1.805	1.985	2.184									
Clamp													
	price per piece	49	49	49									

KODAMA table serie COMBINATION EXAMPLES

design Bart Vos, 2022

prices 2024 in euro excl. VAT

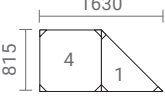
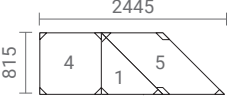
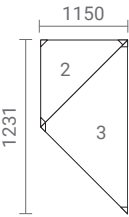
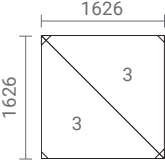
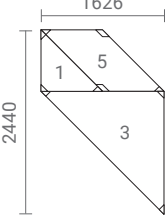
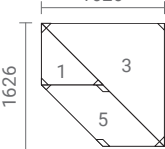
Price examples	Components	beech	oak	walnut	amount	total
		light elm				
Setup 1						
	kodama 4		1.418		1	1.418
	kodama 1		1.269		1	1.269
2.687 oak						
Setup 2						
	kodama 4	1.289			1	1.289
	kodama 1	1.154			1	1.154
	kodama 5	1.805			1	1.805
4.248 light elm						
Setup 3						
	kodama 2			1.896	1	1.896
	kodama 3			2.519	1	2.519
4.415 walnut						
Setup 4						
	kodama 3	2.082			2	4.164 beech
Setup 5a						
	kodama 1		1.269		1	1.269
	kodama 5		1.985		1	1.985
	kodama 3		2.290		1	2.290
5.544 oak						
Setup 5b						
	zelfde set als 5a andere Setup					

KODAMA table serie COMBINATION EXAMPLES

design Bart Vos, 2022

prices 2024 in euro excl. VAT

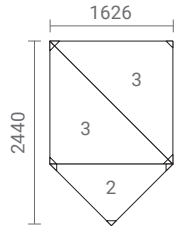
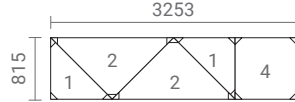
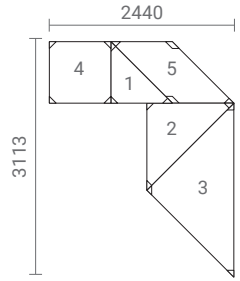
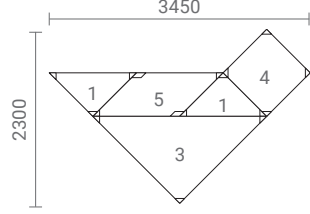
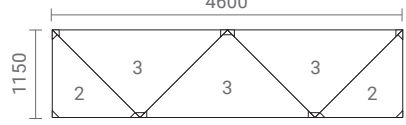
Price examples	Components	wood			amount	total
		beech light elm	oak	walnut		
Setup 6						
						
	kodama 3			2.519	2	5.038
	kodama 2			1.896	1	1.896
						6.934 walnut
Setup 7						
						
	kodama 1		1.269		2	2.538
	kodama 2		1.724		2	3.448
	kodama 4		1.418		1	1.418
						7.404 oak
Setup 8						
						
	kodama 4	1.289			1	1.289
	kodama 1	1.154			1	1.154
	kodama 5	1.805			1	1.805
	kodama 2	1.567			1	1.567
	kodama 3	2.082			1	2.082
						9.188 beech
Setup 9						
						
	kodama 1		1.269		2	2.954
	kodama 5		1.985		1	2.310
	kodama 4		1.418		1	1.650
	kodama 3		2.290		1	2.664
						9.578 oak
Setup 10						
						
	kodama 3	2.082			3	6.246
	kodama 2	1.567			2	3.134
						9.380 light elm

MADS table

design Gjalt Pilat, 2014

prices 2024 in euro excl. VAT

custom sizes on request

dimensions	L x W x H
Mads table	300 x 90 x 76
table top composition	350 x 90 x 76
full lengths in oak	400 x 90 x 76
	450 x 90 x 76
	500 x 90 x 76
	300 x 100 x 76
	350 x 100 x 76
	400 x 100 x 76
	450 x 100 x 76
	500 x 100 x 76

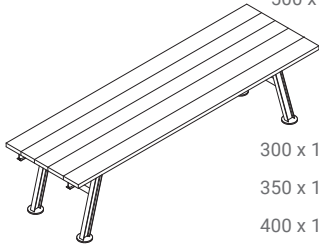

Mads table top composition	300 x 90 x 76
light elm, oak or walnut	350 x 90 x 76
	400 x 90 x 76
	450 x 90 x 76
	500 x 90 x 76

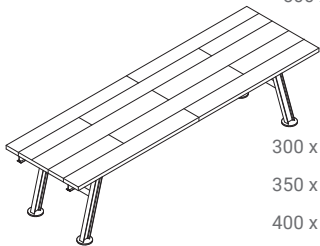

300 x 100 x 76
350 x 100 x 76
400 x 100 x 76
450 x 100 x 76
500 x 100 x 76

light elm

3.521
3.870
4.219
4.569
4.919

3.872
4.257
4.641
5.025
5.411

oak

4.079
4.482
4.887
5.291
5.695

4.484
4.930
5.374
5.819
6.263

oak

3.873
4.257
4.641
5.026
5.411

4.260
4.682
5.105
5.528
5.952

walnut

4.049
4.450
4.852
5.254
5.657

4.453
4.895
5.337
5.779
6.222

key features / additional prices

- see also: Mads bench
- Frame with coating in the standard colors RAL 9004 (black), RAL 9010 (white), Sikkens C4.40.30 (red), F6.05.50 (taupe) or E4.40.40 (caramel). Alternative colors are available on request
- in oak the tabletop consists of 4 or 5 parts with a total width of 90 or 100 cm and full lengths. Ask for the stock and customization options.
- by using wide parts of wood, the delivery time of this table can be longer than usual
- both pictures show a Mads table with an oak table top
- a light elm or walnut table top can be composed as seen on the second picture
- overhang at:
 - length 300 cm: 37 cm
 - length 350 cm: 47 cm
 - length 400 cm: 89.5 cm
 - length 450 cm: 97.5 cm
 - length 500 cm: 100 cm
- The finishing options are according to the solid wood samples such as presented in the current sample box.
- The prices are the same for all finishes; soap, oil, stain-lacquer, transparent lacquer and color lacquer.
- in oak the tabletop is possible in a rustic version; cracks in the tabletop and open knots are filled with black coloured filler. This option does not affect the price.

OVE table

design Studio Slow, 2024

prices 2024 in euro excl. VAT

custom sizes on request

dimensions

L x W x H

Ove 240

200 x 90 x 76
220 x 90 x 76

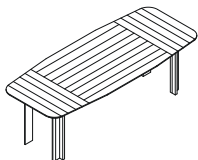

240 x 100 x 76
260 x 100 x 76

280 x 100 x 76

Ove 300

300 x 100 x 76

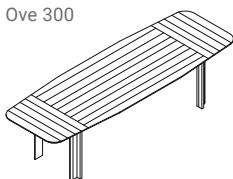

Ove full lengths

200 x 90 x 76
220 x 90 x 76
240 x 100 x 76

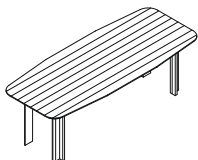

Ove several lengths

260 x 100 x 76
280 x 100 x 76
300 x 100 x 76

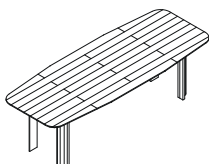

beech

light elm

oak

walnut

2.973

3.270

3.597

3.209

3.529

3.882

3.513

3.864

4.250

3.697

4.066

4.473

3.957

4.353

4.788

4.236

4.659

5.125

2.532

2.785

3.064

2.749

3.024

3.326

3.002

3.302

3.633

3.325

3.657

4.023

3.606

3.966

4.363

3.828

4.211

4.632

key features / additional prices

- table top thickness 3 cm
- Table top can also be composed of full lengths up to length 240. From 260 it will be composed of several lengths.
- finishing options according to the solid wood samples as presented in the current sample box
- prices are the same for all finishes with soap/oil/lacquer/stain lacquer/coloured lacquer
- side view facet table top:



table length	space between the legs in cm
200	135
220	160
240	180
260	185
280	190
300	195

PAKE SYTSE table oval

design Gjalt Pilat, 2010

prices 2024 in euro excl. VAT

custom sizes on request

dimensions

L x W x H

dimensions	L x W x H
Pake Sytse table oval	250 x 130 x 76, 8-legs
	300 x 130 x 76, 10-legs
	350 x 130 x 76, 12-legs
	400 x 130 x 76, 14-legs
	450 x 130 x 76, 16 legs
	500 x 130 x 76, 16-legs

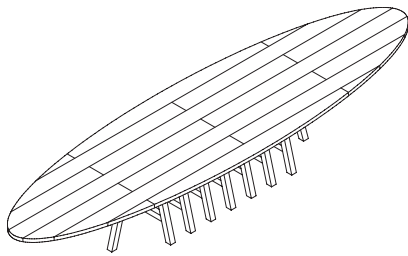

Pake Sytse table round	Ø 160 x 76, 8-legs
	Ø 160 x 104, 8-legs

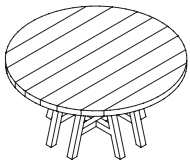

Example option table top edge and frame lacquered in color

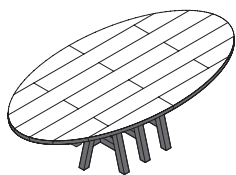

light elm

5.244
6.109
6.972
7.508
7.918
8.326

oak

5.769
6.720
7.670
8.259
8.710
9.158

walnut

6.346
7.392
8.436
9.084
9.581
10.074

key features / additional prices

- thickness of table top is 4 cm
- round Pake Sytse available in two heights, standard height 76 cm and as a bar table, height 104 cm
- composition of the table top alternately 1 and 2 lengths of wood to a table length of 200 cm
- from 250 cm length the tabletop is composed alternately of 2 and 3 lengths
- because of the use of wide parts of wood, the delivery time of this table can be longer than usual
- The finishing options are according to the solid wood samples such as
- presented in the current sample box.
- The prices are the same for all finishes; soap, oil, stain-lacquer, transparent lacquer and color lacquer.
- in oak the tabletop is possible in a rustic version; cracks in the tabletop and open
- knots are filled with black coloured filler. This option does not affect the price.
- option table top edge and base in colored lacquer, no extra charge. See example

OVERVIEW TABLE TOP COMPOSITION:

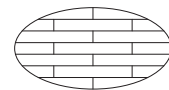

Pake Sytse oval 250 x 130 cm

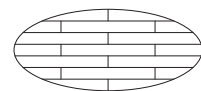

Pake Sytse oval 300 x 130 cm

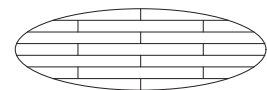

Pake Sytse oval 400 x 130 cm

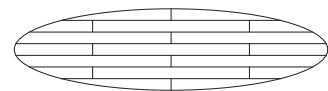

Pake Sytse oval 500 x 130 cm

PAKE SYTSE table Rectangular

design Gjalt Pilat, 2010

prices 2024 in euro excl. VAT

custom sizes on request

dimensions	L x W x H
Pake Sytse table rectangular	200 x 100 x 76, 6-legs
	250 x 110 x 76, 8-legs
	300 x 110 x 76, 10-legs
	350 x 110 x 76, 12-legs
	400 x 110 x 76, 14-legs
	450 x 110 x 76, 16-legs

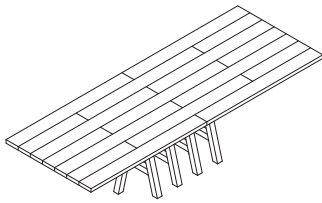

Example option table top edge and frame lacquered in color

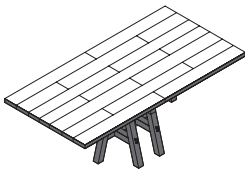

light elm	oak	walnut
3.440	3.784	4.162
4.257	4.682	5.151
5.073	5.580	6.138
5.892	6.481	7.129
6.708	7.378	8.116
7.526	8.278	9.106

key features / additional prices

- thickness of table top is 4 cm
- composition table top alternately 1 and 2 lengths of wood to a table length of 200 cm
- from 250 cm length the tabletop is composed alternately of 2 and 3 lengths
- because of the use of wide parts of wood, the delivery time of this table can be longer than usual
- The finishing options are according to the solid wood samples such as presented in the current sample box.
- The prices are the same for all finishes; soap, oil, stain-lacquer, transparent lacquer and color lacquer.
- in oak the tabletop is possible in a rustic version; cracks in the tabletop and open knots are filled with black coloured filler. This option does not affect the price.
- option table top edge and base in colored lacquer, no extra charge. See example

OVERVIEW TABLE TOP COMPOSITION:

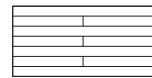

Pake Sytse 200 x 100 cm



Pake Sytse 250 x 110 cm



Pake Sytse 300 x 110 cm



Pake Sytse 350 x 110 cm

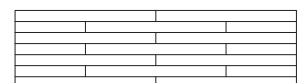

Pake Sytse 400 x 110 cm



Pake Sytse 450 x 110 cm

STIEN table

design Gjalt Pilat 2021

prices 2024 in euro excl. VAT

custom sizes on request

dimensions

L x W x H

light elm

oak

walnut

key features / additional prices

Stien table rectangular

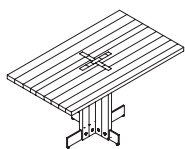

140x80x76	2.374	2.612	2.873
160x80x76	2.491	2.740	3.014
180x80x76	2.743	3.018	3.319
200x90x76	2.856	3.142	3.456
220x90x76	2.968	3.264	3.591

Stien table rectangular

2-legs

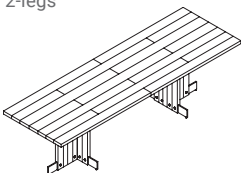

240x90x76	3.433	3.776	4.153
260x90x76	3.519	3.871	4.258
280x90x76	3.862	4.248	4.673
300x90x76	4.250	4.674	5.142
350x100x76	4.611	5.072	5.579
400x100x76	5.277	5.804	6.385

Stien table oval

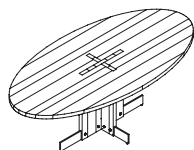

180x110x76	2.986	3.284	3.613
200x110x76	3.172	3.490	3.839
220x110x76	3.397	3.736	4.110

Stien table round

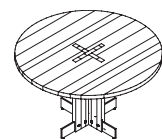

Ø 130x76	3.007	3.308	3.639
Ø 140x76	3.153	3.468	3.815
Ø 150x76	3.312	3.643	4.007
Ø 160x76	3.444	3.789	4.167

- thickness of tabletop is 4 cm
- frame parts and tabletop delivered disassembled
- 2-legged tables: top in 2 to 3 lengths, without wood insert in the top of the sheet
- Space between the legs at 2-legged + recommended number of chairs:
length 240: seat space 76 cm, 6 seats
length 260: seat space 82 cm, 6 seats
length 280: seat space 136 cm, 8 seats
length 300: seat space 146 cm, 8 seats
- frame with coating in the standard colors RAL 9004 (black), RAL 9010 (white), Sikkens C4.40.30 (red), F6.05.50 (taupe) or E4.40.40 (caramel). Alternative colors are available on request
- frame with adjustable feet
- The finishing options are according to the solid wood samples such as presented in the current sample box.
- The prices are the same for all finishes; soap, oil, stain-lacquer, transparent lacquer and color lacquer.

TIEMEN I table

design Gjalt Pilat, 2009

prices 2024 in euro excl. VAT

custom sizes on request

dimensions

L x W x H

Tiemen I table

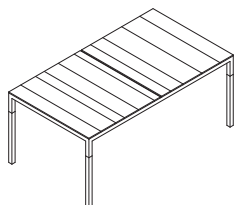

140 x 90 x 76
160 x 90 x 76
180 x 90 x 76
200 x 90 x 76
220 x 90 x 76
240 x 90 x 76
140 x 100 x 76
160 x 100 x 76
180 x 100 x 76
200 x 100 x 76
220 x 100 x 76
240 x 100 x 76

beech

light elm

oak

walnut

1.592	1.751	1.831
1.657	1.823	1.906
1.724	1.897	1.983
1.791	1.970	2.060
1.880	2.068	2.162
1.923	2.115	2.211
1.702	1.872	1.957
1.777	1.955	2.044
1.850	2.035	2.128
1.925	2.117	2.213
1.997	2.197	2.296
2.071	2.278	2.382

key features / additional prices

- tabletop thickness 2 cm, of which 1 cm is visible
- legs and frame 4 x 4 cm
- the lower part of the leg consists of a length of 55 cm solid wood
- with a Tiemen longer than 220 the leg gets a wooden part of 20 cm
- option: legs entirely of steel is also possible without additional cost
- composition from whole lengths of wood, transverse to the direction of the table
- the seam of 1.5 cm in the middle of the tabletop is required, due to the working of the wood
- frame with coating in the standard colors RAL 9004 (black), RAL 9010 (white), Sikkens C4.40.30 (red), F6.05.50 (taupe) or E4.40.40 (caramel). Alternative colors are available on request
- also see: Tiemen coffeetable
- The finishing options are according to the solid wood samples such as presented in the current sample box.
- The prices are the same for all finishes; soap, oil, stain-lacquer, transparent lacquer and color lacquer.

TIEMEN II table

design Gjalt Pilat, 2009

prices 2024 in euro excl. VAT

custom sizes on request

dimensions

Tiemen II table

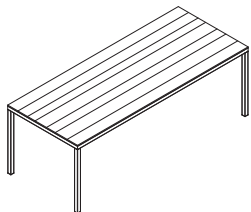

L x W x H

140 x 90 x 76
160 x 90 x 76
180 x 90 x 76
200 x 90 x 76
220 x 90 x 76
240 x 90 x 76
140 x 100 x 76
160 x 100 x 76
180 x 100 x 76
200 x 100 x 76
220 x 100 x 76
240 x 100 x 76

beech

light elm

oak

walnut

1.592	1.751	1.831
1.657	1.823	1.906
1.724	1.897	1.983
1.791	1.970	2.060
1.880	2.068	2.162
1.923	2.115	2.211
1.702	1.872	1.957
1.777	1.955	2.044
1.850	2.035	2.128
1.925	2.117	2.213
1.997	2.197	2.296
2.071	2.278	2.382

key features / additional prices

- tabletop thickness 3 cm, of which 1 cm is visible
- legs and frame 4 x 4 cm
- legs entirely of steel
- composition from whole lengths of wood, in the longitudinal direction of the table
- frame with coating in the standard colors RAL 9004 (black), RAL 9010 (white), Sikkens C4.40.30 (red), F6.05.50 (taupe) or E4.40.40 (caramel). Alternative colors are available on request
- also see: Tiemen I and Tiemen coffeetable
- The finishing options are according to the solid wood samples such as presented in the current sample box.
- The prices are the same for all finishes; soap, oil, stain-lacquer, transparant lacquer and color lacquer.

TOM table

design Chris Slutter, 2018

prices 2024 in euro excl. VAT

custom sizes on request

dimensions

L x W x H

light elm

oak

walnut

key features / additional prices

Tom rectangular

220 x 100 x 76

3.244

3.568

3.730

- tabletop thickness is 4 cm

240 x 100 x 76

3.328

3.661

3.827

- comes in 2 parts: frame and tabletop

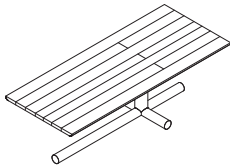

- the largest sizes shown are the maximum possible sizes.

- frame with coating in the standard colors RAL 9004 (black), RAL 9010 (white), Sikkens C4.40.30 (red), F6.05.50 (taupe) or E4.40.40 (caramel). Alternative colors are available on request

Tom oval

220 x 110 x 76

3.332

3.666

3.832

- The finishing options are according to the solid wood samples such as presented in the current sample box.

240 x 110 x 76

3.491

3.840

4.014

- The prices are the same for all finishes; soap, oil, stain-lacquer, transparent lacquer and color lacquer.

260 x 110 x 76

3.652

4.018

4.200

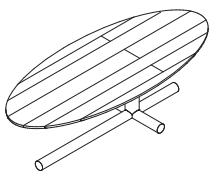

WYBE table

design Gjalt Pilat, 2017

prices 2024 in euro excl. VAT

custom sizes on request

dimensions

L x W x H

Wybe table	200 x 100 x 76
diamond pattern	220 x 100 x 76
	240 x 100 x 76
	260 x 100 x 76
	280 x 100 x 76
	* 300 x 100 x 76

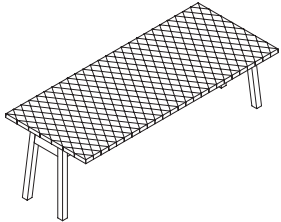

Wybe table full lengths	200 x 100 x 76
	220 x 100 x 76
	240 x 100 x 76
	260 x 100 x 76
	280 x 100 x 76
	* 300 x 100 x 76

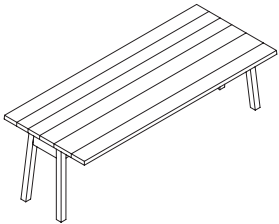

Wybe table	260 x 100 x 76
several lengths	280 x 100 x 76
(walnut)	* 300 x 100 x 76

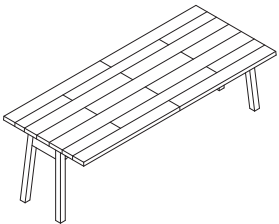

Wybe table round	Ø 130 x 76
full lengths	Ø 140 x 76
	Ø 150 x 76
	Ø 160 x 76

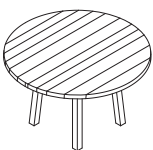

light elm

2.824
2.942
3.060
3.178
3.298
3.501

light elm

1.986
2.056
2.128
2.201
2.272
2.451

oak

2.185
2.262
2.341
2.421
2.499
2.696

walnut

3.417
3.560
3.702
3.845
3.990
4.237

walnut

2.403
2.488
2.575

2.663
2.749
2.966

key features / additional prices

- thickness of tabletop is 4 cm
- the legs measure 6 x 6 cm
- composition of tabletop with diamond pattern or longitudinal wood
- The Wybe in diamond pattern is not possible in oak.
- the Wybe is available with an overhang at the head end, the same as that on the long side: 30 cm. this does not give a price difference.
- the Wybe version full lengths is also available in oak. From 260, walnut (full lengths) is composed of several lengths
- The table tops with a length of * 300 cm are executed with overhang, without overhang a maximum of 280 cm is possible.
- The finishing options are according to the solid wood samples such as presented in the current sample box.
- The prices are the same for all finishes; soap, oil, stain-lacquer, transparent lacquer and color lacquer.

Standard

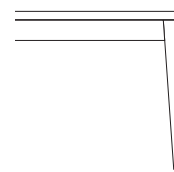

With overhang

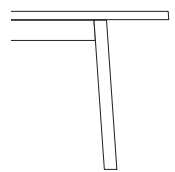

Wybe table with overhang on the head side possible on request

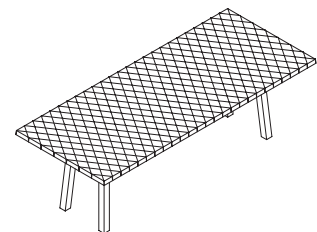

COFFEE TABLES & SMALL TABLES

prices 2024 in euro excl. VAT

COFFEE TABLES

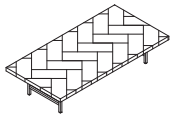

BRUGT
page 34

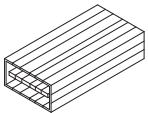

FREEK
page 35

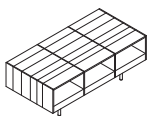

HOTZE
page 36

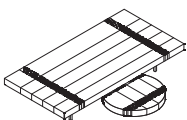

JACOBA
page 37

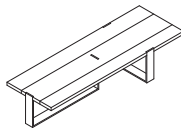

KLAAS
page 38

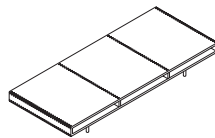

MEINT
page 39

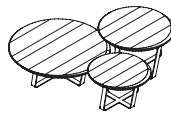

SILAS
page 40

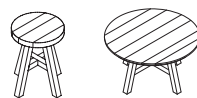

SYTO
page 41

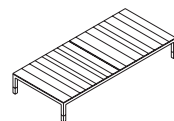

TIEMEN I
page 42

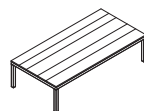

TIEMEN II
page 42

SMALL TABLES



EIRIK
page 43



HYKE
page 43

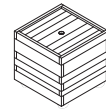

NEL
page 43

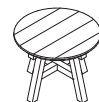

PAKE SYTSE
page 44

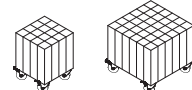

SIEBREN
SMALL/LARGE
page 44



SYL
page 44

BRUGT coffee table

design: Gjalt Pilat, 2021

prices 2024 in euro excl. VAT

custom sizes on request

dimensions

L x W x H

light elm

oak

walnut

key features / additional prices

Brugt coffee table
(height 30cm)

80 x 80 x 30
120 x 120 x 30

1.334
1.931

1.467
2.124

1.534
2.220

- standard table top herringbone pattern

- table top thickness is 3,8 cm

- frame solid steel 2 x 2 cm

- Frame with coating in the standard colors RAL 9004 (black), RAL 9010 (white), Sikkens C4.40.30 (red), F6.05.50 (taupe) or E4.40.40 (caramel). Alternative colors are available on request

- supplied with felt pads and glides

- The finishing options are according to

- the solid wood samples such as

- presented in the current sample box.

- The prices are the same for all finishes;

- soap, oil, stain-lacquer, transparant

- lacquer and color lacquer.

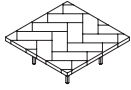

Brugt coffee table
rectangular (height 30cm)

120 x 60 x 30
120 x 80 x 30
140 x 70 x 30
160 x 80 x 30

1.415
1.555
1.589
1.790

1.557
1.711
1.748
1.969

1.627
1.789
1.828
2.059

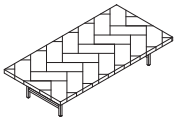

Brugt table 'low dining'
(height 64cm)

80 x 80 x 64
120 x 120 x 64

1.374
1.975

1.511
2.173

1.580
2.272

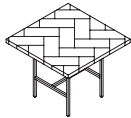

Brugt table rectangular
(height 64cm)

120 x 60 x 64
120 x 80 x 64
140 x 70 x 64
160 x 80 x 64

1.453
1.596
1.636
1.837

1.599
1.756
1.799
2.021

1.671
1.836
1.881
2.112

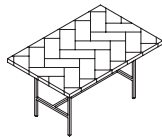

FREEK coffee table

design: Peter Tromop, 2009

prices 2024 in euro excl. VAT

custom sizes on request

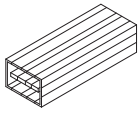
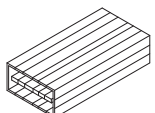
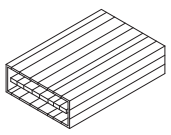
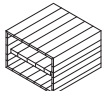
dimensions	L x W x H	light elm	oak	walnut	key features / additional prices	
Freek coffee table 45 cm wide 	80 x 45 x 22	1.111	1.222	1.344	<ul style="list-style-type: none"> • standard colour of the partition board, supporting the shelf F6.03.20 (Grey-Brown) • shelf thickness is 4 cm, wood of the body is 2 cm thick • possible in three heights: 22, 32 cm or 42 cm • coffee table, 22 cm high has no shelf • compartment inside is 34 cm deep • The finishing options are according to the solid wood samples such as presented in the current sample box. • The prices are the same for all finishes; soap, oil, stain-lacquer, transparent lacquer and color lacquer. 	
	80 x 60 x 22	1.245	1.370	1.507		
	80 x 80 x 22	1.368	1.504	1.655		
	120 x 45 x 22	1.319	1.451	1.596		
	120 x 60 x 22	1.474	1.621	1.784		
	120 x 80 x 22	1.621	1.783	1.961		
	160 x 45 x 22	1.524	1.676	1.844		
Freek coffee table 60 cm wide 	160 x 60 x 22	1.719	1.891	2.080		
	160 x 80 x 22	1.898	2.087	2.296		
	80 x 45 x 32	1.317	1.448	1.593		
	80 x 60 x 32	1.445	1.589	1.748		
	80 x 80 x 32	1.586	1.744	1.919		
	Freek coffee table 80 cm wide 	120 x 45 x 32	1.501	1.651		1.816
		120 x 60 x 32	1.676	1.844		2.028
120 x 80 x 32		1.848	2.032	2.236		
160 x 45 x 32		1.708	1.879	2.067		
160 x 60 x 32		1.918	2.110	2.321		
160 x 80 x 32		2.124	2.336	2.570		
80 x 45 x 42		1.317	1.448	1.593		
80 x 60 x 42		1.445	1.589	1.748		
80 x 80 x 42		1.586	1.744	1.919		
120 x 45 x 42		1.605	1.766	1.943		
120 x 60 x 42		1.791	1.970	2.168		
120 x 80 x 42		1.975	2.173	2.390		
160 x 45 x 42		1.815	1.996	2.196		
160 x 60 x 42		2.034	2.237	2.461		
160 x 80 x 42	2.253	2.479	2.727			
Freek coffee table square 60 x 60 	60 x 60 x 22	1.085	1.194	1.313		
	60 x 60 x 32	1.279	1.407	1.548		
	60 x 60 x 42	1.365	1.501	1.652		

HOTZE coffee table

design: Gjalt Pilat, 2002

prices 2024 in euro excl. VAT

custom sizes on request

dimensions

Hotze coffee table

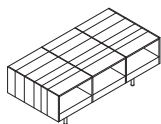

L x W x H

3 compartments:

100 x 50 x 37,5
120 x 60 x 37,5
140 x 70 x 37,5

beech

light elm

oak

walnut

1.177
1.512
1.723

1.295
1.663
1.896

1.424
1.829
2.085

key features / additional prices

- thickness of wood is 1/6 cm
- compartment height 15 cm
- standard steel legs, Ø21 x 150 mm, RAL 9004
- The finishing options are according to the solid wood samples such as presented in the current sample box.
- The prices are the same for all finishes; soap, oil, stain-lacquer, transparent lacquer and color lacquer.

JACOBA coffee table set

design: Gjalt Pilat, 2019

prices 2024 in euro excl. VAT

custom sizes on request

dimensions	L x W x H	light elm	walnut	key features / additional prices
Jacoba coffee table set 	120 x 60 x 27 rectangular + Ø 40 x 17 round	1.852	2.241	<ul style="list-style-type: none"> • table top thickness is 7 cm • height rectangular model: 20 cm; round model 10 cm • legs solid steel 2 x 2 cm • supplied with felt pads and glides • Jacoba is designed as a coffee table set. The rectangular and round element is also offered separately. • Frame with coating in the standard colors RAL 9004 (black), RAL 9010 (white), Sikkens C4.40.30 (red), F6.05.50 (taupe) or E4.40.40 (caramel). Alternative colors are available on request • The finishing options are according to • the solid wood samples such as • presented in the current sample box. • The prices are the same for all finishes; soap, oil, stain-lacquer, transparent lacquer and color lacquer.
	140 x 70 x 27 rectangular + Ø 50 x 17 round	2.036	2.464	
	160 x 80 x 27 rectangular + Ø 60 x 17 round	2.270	2.746	
	Jacoba coffee table round	Ø 40 x 17 Ø 50 x 17 Ø 60 x 17	726 780 849	
Jacoba coffee table rectangular	120 x 60 x 27	1.224	1.481	
	140 x 70 x 27	1.363	1.649	
	160 x 80 x 27	1.540	1.864	

KLAAS coffee table

design: Trude van Assem, 2015

prices 2024 in euro excl. VAT

custom sizes on request

dimensions

Klaas coffee table

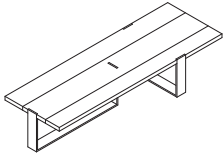

L x W x H

150 x 50 x 30
175 x 50 x 30
200 x 50 x 30
150 x 75 x 30
175 x 75 x 30
200 x 75 x 30

beech

light elm

oak

walnut

1.458	1.604	1.677
1.611	1.772	1.852
1.765	1.941	2.029
1.916	2.108	2.204
2.141	2.355	2.462
2.366	2.603	2.721

key features / additional prices

- thickness of tabletop is 3 cm
- tabletop is composed of full lengths and variable widths
- frame is made of steel size 8 x 1 cm
- frame parts and tabletop are dismountable
- in oak the tabletop is possible in a rustic version; cracks in the tabletop and open knots are filled with black coloured filler. This option does not affect the price.
- also see: Klaas table
- Frame with coating in the standard colors RAL 9004 (black), RAL 9010 (white), Sikkens C4.40.30 (red), F6.05.50 (taupe) or E4.40.40 (caramel). Alternative colors are available on request
- The finishing options are according to
- the solid wood samples such as
- presented in the current sample box.
- The prices are the same for all finishes; soap, oil, stain-lacquer, transparent lacquer and color lacquer.

MEINT coffee table

design: Gjalt Pilat, 1995

prices 2024 in euro excl. VAT

custom sizes on request

dimensions

L x W x H

Meint coffee table

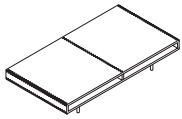

2 compartments:

140 x 61 x 25,5
160 x 61 x 25,5
140 x 76 x 25,5
160 x 76 x 25,5
140 x 91 x 25,5
160 x 91 x 25,5

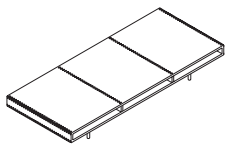

3 compartments:

180 x 76 x 25,5
200 x 76 x 25,5
220 x 76 x 25,5

180 x 91 x 25,5
200 x 91 x 25,5
220 x 91 x 25,5

beech

light elm

oak

walnut

1.936	2.130	2.343
2.004	2.204	2.425
2.085	2.294	2.523
2.184	2.402	2.642
2.508	2.759	3.035
2.624	2.886	3.174
2.289	2.518	2.770
2.391	2.630	2.893
2.508	2.759	3.035
2.747	3.022	3.324
2.873	3.160	3.476
2.994	3.293	3.622

key features / additional prices

- thickness of wood 2 cm, compartment height 6 cm, total height 10 cm
- legs are 15 cm high
- legs standard stainless steel
- for steel legs with black coating a discount of 68,- applies
- The finishing options are according to the solid wood samples such as presented in the current sample box.
- The prices are the same for all finishes; soap, oil, stain-lacquer, transparant lacquer and color lacquer.

SILAS coffee table set

design: Peter Tromop, 2021

prices 2024 in euro excl. VAT

no customization possible

dimensions

Ø x H

oak

walnut

key features / additional prices

Silas coffee table set 1

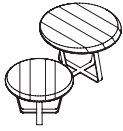

Silas small
Ø 50 x 30
Silas medium
Ø 60 x 40

set price

1.094

set price

1.144

- table top margins have a gradient facet at the top and bottom
- Silas coffee tables delivered assembled
- Steel parts coated on the frame, color RAL 9004
- Silas is designed as a coffee table set
- The prices are the same for all finishes; soap, oil, stain-lacquer, transparent lacquer and color lacquer.

Silas coffee table set 2

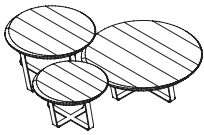

Silas small
Ø 50 x 30
Silas medium
Ø 60 x 40
Silas large
Ø 80 x 25

set price

2.261

set price

2.363

Silas coffee tables

3 sizes (loose)



Silas small
Ø 50 x 30

537

561



Silas medium
Ø 60 x 40

733

766

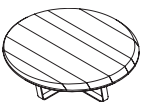

Silas large
Ø 80 x 25

1.172

1.225

SYTO small table & coffee table

design: Gjalt Pilat, 2021

prices 2024 in euro excl. VAT

maatwerk niet mogelijk

dimensions

Ø x H

light elm

oak

walnut

key features / additional prices

Syto small table/stool



Ø 35 x 46

300

330

363

- thickness of top 4 cm
- the coffee tables have a table top finished with a facet (see illustration below)
- The finishing options are according to the solid wood samples such as presented in the current sample box.
- The prices are the same for all finishes; soap, oil, stain-lacquer, transparant lacquer and color lacquer.

Syto coffee table

table top diameter 60 cm



Ø 60 x 37

692

761

837

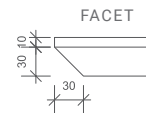

Syto coffee table

table top diameter 70 cm

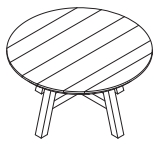

Ø 70 x 37

757

833

916

TIEMEN I coffee table

design: Gjalt Pilat, 2009

prices 2024 in euro excl. VAT

custom sizes on request

dimensions

Tiemen I coffee table

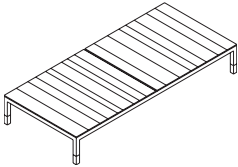

L x W x H
120 x 50 x 30
140 x 60 x 30
160 x 70 x 30
180 x 70 x 30
200 x 75 x 30

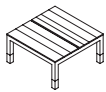

50 x 50 x 30
60 x 60 x 30
70 x 70 x 30
80 x 80 x 30
90 x 90 x 30
100 x 100 x 30

beech

light elm

oak

walnut

1.294	1.424	1.488
1.363	1.499	1.568
1.468	1.615	1.688
1.529	1.681	1.758
1.583	1.741	1.821
1.053	1.158	1.211
1.100	1.210	1.265
1.150	1.264	1.322
1.213	1.334	1.395
1.391	1.530	1.600
1.453	1.599	1.671

key features / additional prices

- tabletop thickness 2 cm, of which 1 cm is visible
- legs and frame frame 3 x 3 cm
- composition from whole lengths of wood, transverse to the direction of the table
- the open joint of 1.5 cm in the middle of the tabletop is necessary, due to the warping of the wood
- Frame with coating in the standard colors RAL 9004 (black), RAL 9010 (white), Sikkens C4.40.30 (red), F6.05.50 (taupe) or E4.40.40 (caramel). Alternative colors are available on request
- also see Tiemen II and Tiemen table
- The finishing options are according to the solid wood samples such as presented in the current sample box.
- The prices are the same for all finishes; soap, oil, stain-lacquer, transparant lacquer and color lacquer.

TIEMEN II coffee table

design: Gjalt Pilat, 2009

custom sizes on request

dimensions

Tiemen II coffee table

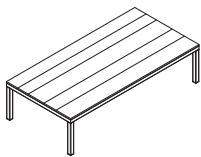

120 x 50 x 30
140 x 60 x 30
160 x 70 x 30
180 x 70 x 30
200 x 75 x 30

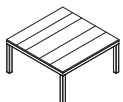

50 x 50 x 30
60 x 60 x 30
70 x 70 x 30
80 x 80 x 30
90 x 90 x 30
100 x 100 x 30

beech

light elm

oak

walnut

1.294	1.424	1.488
1.363	1.499	1.568
1.468	1.615	1.688
1.529	1.681	1.758
1.583	1.741	1.821
1.053	1.158	1.211
1.100	1.210	1.265
1.150	1.264	1.322
1.213	1.334	1.395
1.391	1.530	1.600
1.453	1.599	1.671

key features / additional prices

- tabletop thickness 3 cm, of which 1 cm is visible
- legs and frame frame 3 x 3 cm
- composition from whole lengths of wood, in the longitudinal direction of the table
- Frame with coating in the standard colors RAL 9004 (black), RAL 9010 (white), Sikkens C4.40.30 (red), F6.05.50 (taupe) or E4.40.40 (caramel). Alternative colors are available on request
- also see Tiemen I and Tiemen table
- The finishing options are according to the solid wood samples such as presented in the current sample box.
- The prices are the same for all finishes; soap, oil, stain-lacquer, transparant lacquer and color lacquer.

PILAT &
PILAT

SMALL TABLES

prices 2024 in euro excl. VAT

customization not possible

dimensions

L x W x H

light elm

oak

walnut

key features / additional prices

EIRIK

design: Peter Tromop, 2007

30 x 30 x 35

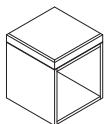

358

394

434

- The finishing options are according to the solid wood samples such as presented in the current sample box.
- The prices are the same for all finishes; soap, oil, stain-lacquer, transparent lacquer and color lacquer.
- also see Eirik cupboard

HYKE

design: Gjalt Pilat, 2009

34 x 26 x 75,5

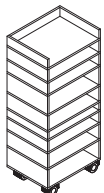

713

785

863

- on black swivel wheels
- The finishing options are according to the solid wood samples such as presented in the current sample box.
- The prices are the same for all finishes; soap, oil, stain-lacquer, transparent lacquer and color lacquer.

NEL

design: Peter Tromop, 2009

40 x 40 x 45

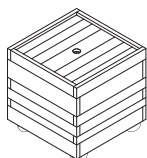

670

737

811

- on black swivel wheels with total stop brake
- The finishing options are according to the solid wood samples such as presented in the current sample box.
- The prices are the same for all finishes; soap, oil, stain-lacquer, transparent lacquer and color lacquer.

SMALL TABLES

prices 2024 in euro excl. VAT

customization not possible

dimensions

L x W x H

light elm

oak

walnut

key features / additional prices

PAKE SYTSE

design: Gjalt Pilat, 2015



Ø 50 x 37

490

539

593

- thickness of tabletop 3 cm
- frame is made of 3 x 3 cm solid wood
- The finishing options are according to the solid wood samples such as presented in the current sample box.
- The prices are the same for all finishes; soap, oil, stain-lacquer, transparent lacquer and color lacquer.
- also see Pake Sytse table and Syto stool



Ø 50 x 52

526

578

636

SIEBREN SMALL

design: Gjalt Pilat, 2009



28 x 28 x 40

484

586

- on black swivel wheels with total stop brake
- The finishing options are according to the solid wood samples such as presented in the current sample box.
- The prices are the same for all finishes; soap, oil, stain-lacquer, transparent lacquer and color lacquer.
- * Siebren is not possible in oak

SIEBREN LARGE

design: Gjalt Pilat, 2009

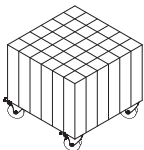

42 x 42 x 40

621

752

- on black swivel wheels with total stop brake
- The finishing options are according to the solid wood samples such as presented in the current sample box.
- The prices are the same for all finishes; soap, oil, stain-lacquer, transparent lacquer and color lacquer.
- * Siebren is not possible in oak

SYL

design: Bas van der Veer, 2014

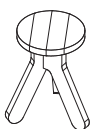

Ø 30 x 45

291

321

353

- The finishing options are according to the solid wood samples such as presented in the current sample box.
- The prices are the same for all finishes; soap, oil, stain-lacquer, transparent lacquer and color lacquer.

DESKS

prices 2024 in euro excl. VAT

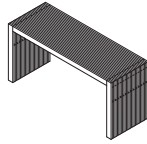

BAS
page 46

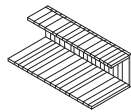

KEES
page 47

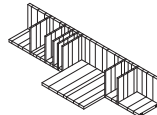

LUTGARDE
page 48

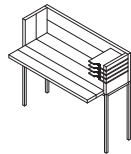

WILKE
page 49

BAS desk

design: Gjalt Pilat, 2001

prices 2024 in euro excl. VAT

custom sizes on request

dimensions

Bas desk

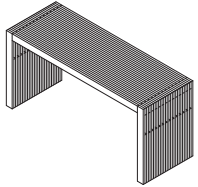

W x D x H

140 x 62 x 76

160 x 62 x 76

180 x 62 x 76

light elm

1.921

2.050

2.195

oak

2.113

2.255

2.415

walnut

2.324

2.480

2.656

key features / additional prices

- made of 6,8 cm thick wood
- composed of various lengths from 40 to 100 cm
- The finishing options are according to the solid wood samples such as presented in the current sample box.
- The prices are the same for all finishes; soap, oil, stain-lacquer, transparent lacquer and color lacquer.

KEES desk

design: Gjalt Pilat, 2007

prices 2024 in euro excl. VAT

dimensions

Kees desk

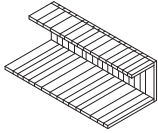

custom sizes on request

W x D x H

120 x 57 x 40

beech

light elm

1.522

oak

1.675

walnut

1.842

key features / additional prices

- thickness of tabletop 3 cm
- desk is attached to four hooks that are screwed into the wall
- The finishing options are according to the solid wood samples such as presented in the current sample box.
- The prices are the same for all finishes; soap, oil, stain-lacquer, transparant lacquer and color lacquer.

LUTGARDE desk

design: Gjalt Pilat, 2012

prices 2024 in euro excl. VAT

custom sizes on request

dimensions

W x D x H

Lutgarde desk

187 x 30/60 x 33

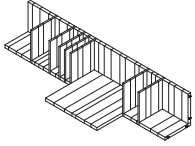

beech

light elm

oak

walnut

2.279

2.506

2.757

key features / additional prices

- thickness of tabletop 3 cm
- desk is attached to four hooks that are screwed into the wall
- also see: Lutgarde shelving unit
- The finishing options are according to the solid wood samples such as presented in the current sample box.
- The prices are the same for all finishes; soap, oil, stain-lacquer, transparent lacquer and color lacquer.

WILKE desk

design: Gjalt Pilat, 2012

prices 2024 in euro excl. VAT

custom sizes on request

dimensions

W x D x H

Wilke desk

120 x 60 x 107,5

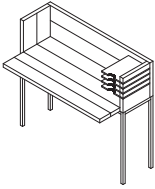

light elm

2.395

oak

2.634

walnut

2.898

key features / additional prices

- thickness of desk top 3,6 cm
- height desk top 76 cm
- frame is made of solid steel
- Frame with coating in the standard colors RAL 9004 (black), RAL 9010 (white), Sikkens C4.40.30 (red), F6.05.50 (taupe) or E4.40.40 (caramel). Alternative colors are available on request
- The finishing options are according to the solid wood samples such as presented in the current sample box.
- The prices are the same for all finishes; soap, oil, stain-lacquer, transparent lacquer and color lacquer.

--	--	--	--

BENCHES

prices 2024 in euro excl. VAT



BAS
page 52

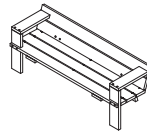

**BERTHE
OUTDOOR**
page 53

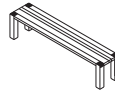

DORUS
page 54



DÛBELD
page 55

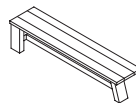

ELIZABETH II
page 56

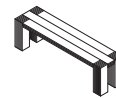

**HINDRIK
LANGSHOUT**
page 57

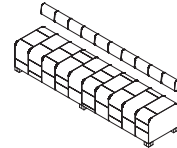

HINKE
page 58

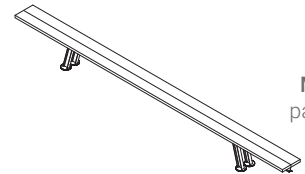

MADS
page 59

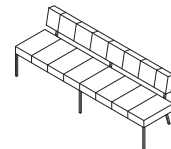

MARJELLE
page 60-61

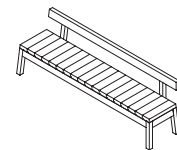

WYBE
page 62-65

BAS bench

design: Gjalt Pilat, 2001

prices 2024 in euro excl. VAT

custom sizes on request

dimensions

Bas bench

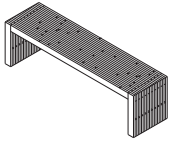

W x D x H

160 x 42 x 45
180 x 42 x 45
200 x 42 x 45
220 x 42 x 45
240 x 42 x 45

light elm

1.600
1.621
1.652
1.706
1.762

oak

1.760
1.783
1.817
1.876
1.938

walnut

1.936
1.961
1.999
2.064
2.132

key features / additional prices

- thickness of wood 6,8 cm
- composition of variable lengths, from 40 to 100 cm
- also see: Bas table
- The finishing options are according to
- the solid wood samples such as
- presented in the current sample box.
- The prices are the same for all finishes; soap, oil, stain-lacquer, transparent lacquer and color lacquer.

BERTHE bench outdoor

design: Gjalt Pilat / Peter Tromop, 2007

prices 2024 in euro excl. VAT

no customization possible

dimensions

W x D x H

Berthe bench

200 x 65 x 74

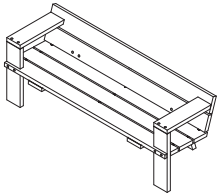

douglas

untreated

1.739

key features / additional prices

- seat height 40 cm, seat depth 49 cm
- height arm rests 67 cm
- thickness of wood 4 cm
- metal parts are brass
- untreated douglas becomes gray over time

DORUS bench

design: Gjalt Pilat, 1998

prices 2024 in euro excl. VAT

custom sizes on request

dimensions

W x D x H

Dorus bench

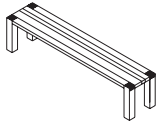

160 x 42 x 45
180 x 42 x 45
200 x 42 x 45
220 x 42 x 45
240 x 42 x 45

light elm

1.371
1.423
1.678
1.751
1.820

oak

1.508
1.565
1.846
1.926
2.002

walnut

1.659
1.722
2.030
2.119
2.202

key features / additional prices

- thickness of seat 4 cm
- the leg of a Dorus table is 8,8 x 8,8 cm
- also see: Dorus table
- The finishing options are according to
- the solid wood samples such as
- presented in the current sample box.
- The prices are the same for all finishes; soap, oil, stain-lacquer, transparent lacquer and color lacquer.

DÛBELD storage seatbox

design: Kristien Pilat, 2008

prices 2024 in euro excl. VAT

custom sizes on request

dimensions

W x D x H

Dûbeld storage seatbox

126 x 39 x 44,5

144 x 39 x 44,5

162 x 39 x 44,5

180 x 39 x 44,5

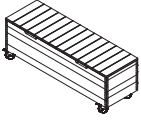

light elm

1.501

1.563

1.625

1.686

oak

1.651

1.719

1.788

1.854

walnut

1.816

1.891

1.966

2.040

key features / additional prices

- on black castors with total stop brake
- 2 flaps with a damping closing system
- bottom of solid wood
- The finishing options are according to
- the solid wood samples such as
- presented in the current sample box.
- The prices are the same for all finishes; soap, oil, stain-lacquer, transparent lacquer and color lacquer.

ELIZABETH II bench

design: Gjalt Pilat, 2004

prices 2024 in euro excl. VAT

custom sizes on request

dimensions

W x D x H

light elm

oak

walnut

key features / additional prices

Elizabeth II bench, 3 legs

160 x 45 x 45

1.499

1.649

1.814

- from 160 cm on three legs

170 x 45 x 45

1.531

1.684

1.853

- from 240 cm on four legs

180 x 45 x 45

1.562

1.718

1.890

- from 260 cm the seating panel is

200 x 45 x 45

1.620

1.782

1.960

- composed of two or three lengths as

220 x 45 x 45

1.676

1.844

2.028

- shown on the pictures

- the legs measure 6 x 12 cm

- also see: Elizabeth II table

- The finishing options are according to

- the solid wood samples such as

- presented in the current sample box.

- The prices are the same for all finishes;

- soap and / or oil, stain-lacquer,

- transparent lacquer and colour lacquer.

Elizabeth II bench, 4 legs

240 x 45 x 45

1.999

2.199

2.418

260 x 45 x 45

2.228

2.451

2.696

280 x 45 x 45

2.276

2.503

2.754

300 x 45 x 45

2.323

2.556

2.811

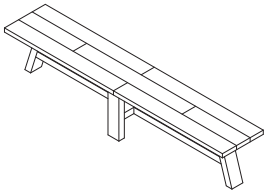
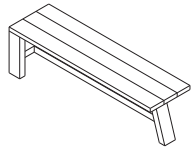

HINDRIK LANGSHOUT bench

design: Gjalt Pilat, 2004

prices 2024 in euro excl. VAT

custom sizes on request

dimensions

W x D x H

light elm

oak

walnut

key features / additional prices

Hindrik Langshout bench

160 x 40,5 x 45

1.770

1.947

2.142

180 x 40,5 x 45

1.860

2.046

2.251

200 x 40,5 x 45

1.947

2.142

2.356

220 x 40,5 x 45

2.037

2.241

2.465

240 x 40,5 x 45

2.127

2.339

2.573

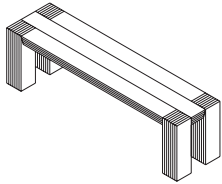

260 x 40,5 x 45

2.215

2.437

2.680

280 x 40,5 x 45

2.304

2.535

2.788

300 x 40,5 x 45

2.394

2.633

2.897

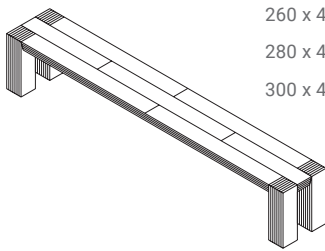

320 x 40,5 x 45

2.573

2.831

3.114

340 x 40,5 x 45

2.663

2.929

3.222

360 x 40,5 x 45

2.752

3.027

3.330

380 x 40,5 x 45

2.841

3.125

3.437

400 x 40,5 x 45

2.930

3.223

3.545

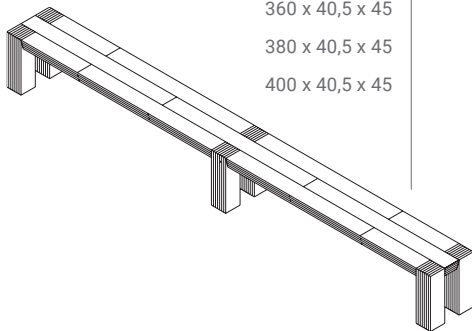

- from 240 cm on four legs
- from 320 cm on six legs
- the seat panel of the Hindrik Langshout bench is composed of fixed widths of 13,5 x 13,5 cm
- the legs measure 13,5 x 13,5 cm
- from 260 cm the seat panel is composed of two or three lengths as shown on the pictures
- also see: Hindrik Langshout table
- The finishing options are according to
- the solid wood samples such as
- presented in the current sample box.
- The prices are the same for all finishes; soap, oil, stain-lacquer, transparant lacquer and color lacquer.

HINKE bench

design: Gjal't Pilat, 2010

prices 2024 in euro excl. VAT

custom sizes on request

dimensions

W x D x H

dimensions	W x D x H
Hinke bench with backrest	180 x 55 x 48
	200 x 55 x 48
	220 x 55 x 48
	240 x 55 x 48
	260 x 55 x 48
	280 x 55 x 48
	300 x 55 x 48
	320 x 55 x 48
	340 x 55 x 48

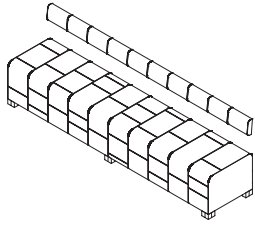

lined with leather

without backrest

2.380	1.803
2.568	1.932
2.755	2.060
2.915	2.166
3.049	2.245
3.156	2.301
3.262	2.355
3.370	2.413
3.525	2.511

key features / additional prices

- please mention the kind of wood of the legs when ordering (oak/light elm/walnut)
- backrest mounted on the wall
- backrest tilts slightly backwards and is 17 cm high
- possible leathers: Ohman Nero, Dark Brown, Havana furthermore sheepskin leather light brown, dark brown and black.
- stitching in three possible colours; black, brown or sand colour.
- customers own material on request.

MADS bench

design: Gjalt Pilat, 2015

prices 2024 in euro excl. VAT

custom sizes on request

dimensions

W x D x H

light elm

oak

walnut

key features / additional prices

300 x 33 x 47

2.049

2.254

•

• also see: Mads table

350 x 33 x 47

2.124

2.336

•

• Frame with coating in the standard

400 x 33 x 47

2.201

2.421

•

colors RAL 9004 (black), RAL 9010

450 x 33 x 47

2.276

2.503

•

(white), Sikkens C4.40.30 (red), F6.05.50

500 x 33 x 47

2.352

2.587

•

(taupe) or E4.40.40 (caramel). Alternative colors are available on request

• the seat consists of 2 to 4 parts with a total width of 33 cm

• The finishing options are according to

• the solid wood samples such as

• presented in the current sample box.

• The prices are the same for all finishes;

soap and / or oil, stain-lacquer,

transparent lacquer and colour lacquer.

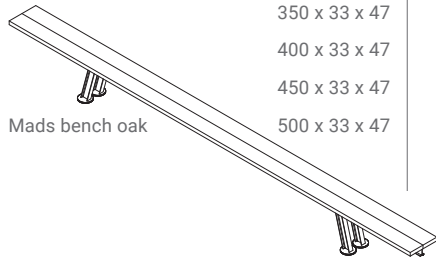

Mads bench oak

300 x 33 x 47

1.946

2.141

2.238

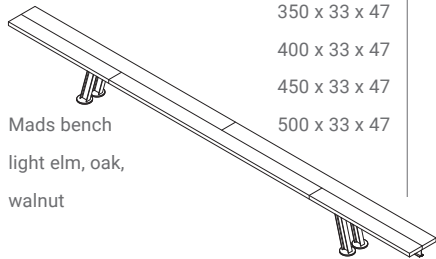

Mads bench
light elm, oak,
walnut

350 x 33 x 47

2.017

2.218

2.319

400 x 33 x 47

2.090

2.299

2.403

450 x 33 x 47

2.161

2.378

2.486

500 x 33 x 47

2.234

2.457

2.569

MARJELLE bench

design: Gjalt Pilat, 2019

prices 2024 in euro excl. VAT

custom sizes on request

dimensions	W x D x H
Marjelle bench	121 x 67 x 78
	141 x 67 x 78
	161 x 67 x 78
	181 x 67 x 78
	201 x 67 x 78
	221 x 67 x 78
	241 x 67 x 78
	261 x 67 x 78
	281 x 67 x 78
	301 x 67 x 78

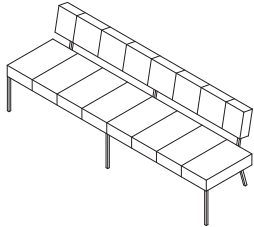

cow leather

sheep leather

customers own request

fabric required

key features / additional prices

- seat height approx. 49 cm, net
 - seat depth approx. 47 cm
 - possible cow leathers: Ohmann Nero, Dark Brown, Havana, furthermore sheep leathers: light brown, dark brown and black
 - stitching in three possible colours; black, brown or sand colour. please mention your choice when ordering
 - COM (customers own material) excludes fabric and includes upholstery
-
- **NEW** from the date of this price list we take care of the purchase of the fabrics from fabric manufacturer KVADRAT. For prices including fabric and upholstery, consult the table next to it. Clearly indicate on the order which fabric name, color number and fabric group it concerns.
-
- other fabric brands: send in fabric and calculate price based on linen price and indicated fabric metersage
 - Frame with coating in the standard colors RAL 9004 (black), RAL 9010 (white), Sikkens C4.40.30 (red), F6.05.50 (taupe) or E4.40.40 (caramel). Alternative colors are available on request
 - supplied with felt pads and glides

MARJELLE bench upholstered with Kvadrat fabric

design: Gjalt Pilat, 2019

prices 2024 in euro excl. VAT

dimensions	group	group	group	group	group	group	KVADRAT fabrics
W x D x H	A	B	C	D	E	F	
121 x 67 x 78		1.847	1.865	1.910	1.937	2.118	<ul style="list-style-type: none"> Fabric group A: Fabric group B: Canvas, Naveli, Remix Fabric group C: Mizmaze, Moss, Re-wool Fabric group D: Safire, Steelcut Trio, Zero Fabric group E: Cifrado, Hallingdal Fabric group F: Coda, Rumor
141 x 67 x 78		2.025	2.047	2.103	2.137	2.360	<hr/> <ul style="list-style-type: none"> choice of other fabric types Kvadrat is also possible. Please indicate the fabric choice and number clearly on the order. other fabric brands: send in fabric and calculate price based on linen price and indicated fabric metersage
161 x 67 x 78		2.144	2.168	2.228	2.264	2.505	
181 x 67 x 78		2.313	2.340	2.406	2.446	2.713	
201 x 67 x 78		2.465	2.494	2.567	2.611	2.903	
221 x 67 x 78		2.651	2.683	2.765	2.814	3.141	
241 x 67 x 78		2.831	2.867	2.958	3.012	3.373	
261 x 67 x 78		3.074	3.119	3.231	3.298	3.745	
281 x 67 x 78		3.474	3.526	3.655	3.732	4.248	
301 x 67 x 78		3.858	3.918	4.069	4.159	4.761	

WYBE bench WITH WOODEN BACKREST

design: Gjalt Pilat, 2017

prices 2024 in euro excl. VAT

custom sizes on request

dimensions

W x D x H

light elm

oak

walnut

fabric required

key features / additional prices

Wybe bench with wooden backrest (4 legs until length 280)

200 x 61,5 x 79

COM

2.251

2.476

2.588

1,7 meters

220 x 61,5 x 79

COM

2.326

2.558

2.675

1,8 meters

240 x 61,5 x 79

COM

2.402

2.642

2.762

1,9 meters

260 x 61,5 x 79

COM

2.487

2.735

2.860

2,1 meters

280 x 61,5 x 79

COM

2.571

2.828

2.956

2,2 meters

Wybe bench with wooden backrest (6 legs from length 300)

300 x 61,5 x 79

COM

3.045

3.349

3.501

2,3 meters

320 x 61,5 x 79

COM

3.244

3.568

3.730

2,4 meters

340 x 61,5 x 79

COM

3.448

3.792

3.965

2,6 meters

360 x 61,5 x 79

COM

3.652

4.018

4.200

2,7 meters

380 x 61,5 x 79

COM

3.857

4.243

4.436

2,9 meters

400 x 61,5 x 79

COM

4.014

4.415

4.616

3,0 meters

- the legs measure 6 x 6 cm
 - possible leathers: Ohman Nero, Dark Brown, Havana furthermore sheepskin leather light brown, dark brown and black.
 - stitching in three possible colours; black, brown or sand colour. please mention your choice when ordering
 - COM (customers own material) excludes fabric and includes upholstery
-
- **NEW** from the date of this price list we take care of the purchase of the fabrics from fabric manufacturer KVADRAT. For prices including fabric and upholstery, consult the table next to it. Clearly indicate on the order which fabric name, color number and fabric group it concerns.
-
- other fabric brands: send in fabric and calculate price based on linen price and indicated fabric metersage
 - The finishing options are according to the solid wood samples such as presented in the current sample box.
 - with oak the legs and backrest are glued together in two parts.
 - The prices are the same for all finishes; soap and / or oil, stain-lacquer, transparant lacquer and colour lacquer.
 - see also Wybe bench with upholstered backrest and Wybe table.

Wybe bench WOODEN BACKREST upholstered with Kvadrat fabric

design: Gjalt Pilat, 2017

prices 2024 in euro excl. VAT

dimensions	group	group	group	group	group	group	KVADRAT fabrics
W x D x H	A	B	C	D	E	F	
200 x 61,5 x 79							<ul style="list-style-type: none"> • Fabric group A: • Fabric group B: Canvas, Naveli, Remix • Fabric group C: Mizmaze, Moss, Re-wool • Fabric group D: Safire, Steelcut Trio, Zero • Fabric group E: Cifrado, Hallingdal • Fabric group F: Coda, Rumor <hr/> <ul style="list-style-type: none"> • choice of other fabric types Kvadrat is also possible. Please indicate the fabric choice and number clearly on the order. • other fabric brands: send in fabric and calculate price based on linen price and indicated fabric metersage
light elm		1.930	1.944	1.980	2.003	2.149	
oak		2.100	2.114	2.151	2.173	2.319	
walnut		2.186	2.200	2.236	2.259	2.405	
220 x 61,5 x 79							
light elm		1.999	2.015	2.053	2.077	2.231	
oak		2.176	2.192	2.230	2.254	2.408	
walnut		2.264	2.279	2.318	2.341	2.496	
240 x 61,5 x 79							
light elm		2.071	2.087	2.127	2.152	2.316	
oak		2.253	2.269	2.310	2.334	2.498	
walnut		2.344	2.360	2.401	2.426	2.589	
260 x 61,5 x 79							
light elm		2.161	2.179	2.224	2.251	2.432	
oak		2.349	2.367	2.413	2.439	2.620	
walnut		2.444	2.462	2.507	2.534	2.714	
280 x 61,5 x 79							
light elm		2.236	2.255	2.303	2.331	2.520	
oak		2.432	2.451	2.499	2.527	2.716	
walnut		2.530	2.548	2.596	2.624	2.813	
300 x 61,5 x 79							
light elm		2.610	2.630	2.679	2.709	2.907	
oak		2.842	2.861	2.910	2.940	3.138	
walnut		2.957	2.976	3.026	3.056	3.253	
320 x 61,5 x 79							
light elm		2.774	2.795	2.847	2.878	3.084	
oak		3.021	3.042	3.093	3.127	3.331	
walnut		3.145	3.166	3.217	3.248	3.454	
340 x 61,5 x 79							
light elm		2.956	2.977	3.033	3.067	3.290	
oak		3.217	3.239	3.295	3.329	3.552	
walnut		3.348	3.370	3.426	3.460	3.683	
360 x 61,5 x 79							
light elm		3.124	3.148	3.206	3.240	3.472	
oak		3.402	3.425	3.484	3.518	3.750	
walnut		3.541	3.564	3.622	3.657	3.889	
380 x 61,5 x 79							
light elm		3.305	3.330	3.392	3.429	3.679	
oak		3.598	3.623	3.686	3.723	3.972	
walnut		3.745	3.770	3.832	3.869	4.119	
400 x 61,5 x 79							
light elm		3.438	3.464	3.528	3.567	3.825	
oak		3.742	3.768	3.833	3.871	4.129	
walnut		3.895	3.921	3.986	4.024	4.282	

WYBE bench WITH UPHOLSTERED BACKREST

design: Gjalt Pilat, 2017

prices 2024 in euro excl. VAT

custom sizes on request

dimensions

W x D x H

light elm

oak

walnut

fabric required

key features / additional prices

Wybe bench with wooden backrest (4 legs until length 280)

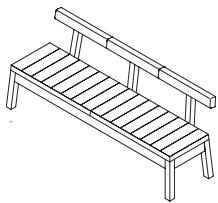

200 x 61,5 x 79

COM

2.623

2.885

3.016

2,6 meters

220 x 61,5 x 79

COM

2.720

2.992

3.128

2,8 meters

240 x 61,5 x 79

COM

2.822

3.104

3.245

3,0 meters

260 x 61,5 x 79

COM

2.984

3.282

3.431

3,2 meters

280 x 61,5 x 79

COM

3.129

3.441

3.598

3,4 meters

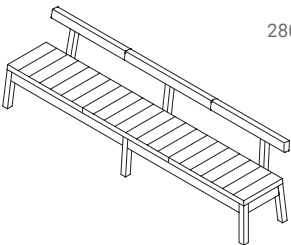

Wybe bench with wooden backrest (6 legs from length 300)

300 x 61,5 x 79

COM

3.547

3.902

4.079

3,6 meters

320 x 61,5 x 79

COM

3.779

4.157

4.346

3,8 meters

340 x 61,5 x 79

COM

4.017

4.419

4.620

4,0 meters

360 x 61,5 x 79

COM

4.255

4.680

4.893

4,2 meters

380 x 61,5 x 79

COM

4.493

4.942

5.167

4,4 meters

400 x 61,5 x 79

COM

4.677

5.144

5.378

4,6 meters

- the legs measure 6 x 6 cm
 - possible leathers: Ohman Nero, Dark Brown, Havana furthermore sheepskin leather light brown, dark brown and black.
 - stitching in three possible colours;; black, brown or sand colour. please mention your choice when ordering
 - COM (customers own material) excludes fabric and includes upholstery
-
- **NEW** from the date of this price list we take care of the purchase of the fabrics from fabric manufacturer KVADRAT. For prices including fabric and upholstery, consult the table next to it. Clearly indicate on the order which fabric name, color number and fabric group it concerns.
-

- other fabric brands: send in fabric and calculate price based on linen price and indicated fabric metersage
- The finishing options are according to the solid wood samples such as presented in the current sample box.
- with oak the legs and backrest are glued together in two parts.
- The prices are the same for all finishes; soap and / or oil, stain-lacquer, transparant lacquer and colour lacquer.
- see also Wybe bench with wooden backrest and Wybe table.

Wybe bench UPHOLSTERED BACKREST including Kvadrat fabric

design: Gjalt Pilat, 2017

prices 2024 in euro excl. VAT

dimensions	group	group	group	group	group	group
W x D x H	A	B	C	D	E	F
200 x 61,5 x 79						
light elm		2.328	2.351	2.407	2.440	2.664
oak		2.528	2.550	2.606	2.640	2.863
walnut		2.628	2.650	2.706	2.739	2.963
220 x 61,5 x 79						
light elm		2.429	2.453	2.513	2.549	2.790
oak		2.635	2.659	2.719	2.756	2.996
walnut		2.738	2.762	2.823	2.859	3.099
240 x 61,5 x 79						
light elm		2.531	2.557	2.621	2.660	2.918
oak		2.745	2.771	2.836	2.874	3.132
walnut		2.853	2.878	2.943	2.982	3.239
260 x 61,5 x 79						
light elm		2.679	2.707	2.775	2.817	3.092
oak		2.906	2.933	3.002	3.044	3.319
walnut		3.019	3.047	3.116	3.157	3.432
280 x 61,5 x 79						
light elm		2.816	2.845	2.918	2.962	3.254
oak		3.054	3.083	3.156	3.200	3.492
walnut		3.691	3.725	3.810	3.861	4.201
300 x 61,5 x 79						
light elm		3.160	3.191	3.269	3.315	3.625
oak		3.429	3.460	3.538	3.584	3.894
walnut		3.564	3.595	3.673	3.719	4.028
320 x 61,5 x 79						
light elm		3.362	3.395	3.477	3.526	3.852
oak		3.649	3.682	3.764	3.813	4.139
walnut		3.793	3.826	3.907	3.956	4.283
340 x 61,5 x 79						
light elm		3.569	3.603	3.689	3.741	4.084
oak		3.874	3.908	3.994	4.046	4.389
walnut		4.026	4.060	4.146	4.198	4.542
360 x 61,5 x 79						
light elm		3.776	3.812	3.902	3.956	4.317
oak		4.099	4.135	4.225	4.279	4.640
walnut		4.261	4.297	4.387	4.441	4.802
380 x 61,5 x 79						
light elm		3.983	4.021	4.115	4.172	4.550
oak		4.324	4.362	4.457	4.513	4.891
walnut		4.495	4.533	4.628	4.684	5.062
400 x 61,5 x 79						
light elm		4.147	4.187	4.285	4.345	4.740
oak		4.503	4.542	4.641	4.701	5.096
walnut		4.680	4.720	4.817	4.878	5.273

KVADRAT fabrics

- Fabric group A:
 - Fabric group B: Canvas, Naveli, Remix
 - Fabric group C: Mizmaze, Moss, Re-wool
 - Fabric group D: Safire, Steelcut Trio, Zero
 - Fabric group E: Cifrado, Hallingdal
 - Fabric group F: Coda, Rumor
-
- choice of other fabric types Kvadrat is also possible. Please indicate the fabric choice and number clearly on the order.
- other fabric brands: send in fabric and calculate price based on linen price and indicated fabric metersage

ARMCHAIRS CHAIRS

prices 2024 in euro excl. VAT



LUDY
page 72



DINY
page 68



LUTSKE
page 73



FROUKJE III
page 69



PAS
page 74



GRETA
page 70



SYL
page 75



HITOSHI
page 71



SYTO
page 76

DINY chair

design: Kristien Pilat, 2014

prices 2024 in euro excl. VAT

no customization possible

dimensions

W x D x H

Diny chair

55,5 x 54 x 86



leather

light elm

844

oak

928

walnut

970

COM

excluding fabric

787

865

905

including upholstery

KVADRAT FABRICS

A

B

864

943

982

C

869

948

987

D

882

961

1.000

E

890

969

1.007

F

941

1.020

1.059

key features / additional prices

- possible leathers: Ohman Nero, Dark Brown, Havana furthermore sheepskin leather light brown, dark brown and black.
 - stitching in three possible colours: black, brown or sand colour. please mention your choice when ordering
 - width 55.5 cm, depth 54 cm, height 86 cm, height armrest 65 cm
-
- **NEW** from the date of this price list we take care of the purchase of the fabrics from fabric manufacturer KVADRAT. For prices including fabric and upholstery, consult the table next to it. Clearly indicate on the order which fabric name, color number and fabric group it concerns.
-
- the amount of fabric is determined by the number of chairs:
1 chair 0,60 m | 4 chairs 1,20 m
2 chairs 0,60 m | 5 chairs 1,80 m
3 chairs 1,20 m | 6 chairs 1,80 m
 - mentioned fabric prices Kvadrat are based on 1 chair
 - choice of other fabric types Kvadrat is also possible. Please indicate the fabric choice and number clearly on the order.
 - other fabric brands: send in fabric and calculate price based on linen price and indicated fabric meterage
 - finishing possibilities according to the solid wood samples as presented in a current sample box
 - The prices are the same for all finishes; soap, oil, stain-lacquer, transparent lacquer and color lacquer.

KVADRAT fabrics

- Fabric group A:
- Fabric group B: Canvas, Naveli, Remix
- Fabric group C: Mizmaze, Moss, Re-wool
- Fabric group D: Safire, Steelcut Trio, Zero
- Fabric group E: Cifrado, Hallingdal
- Fabric group F: Coda, Rumor

FROUKJE chair

design: Gjalt Pilat, 2015

prices 2024 in euro excl. VAT

no customization possible

dimensions

W x D x H

Froukje III chair

56,5 x 60 x 81

including leather
including upholstery



KVADRAT

FABRICS

A

B

C

D

E

F

cow
leather

sheep
leather

898

customers
own
material

531

fabric
required

1,9 meters

776

792

834

858

1.021

key features / additional prices

- possible leathers: Ohman Nero, Dark Brown, Havanna furthermore sheepskin leather light brown, dark brown and black.
- stitching in three possible colours; black, brown or sand colour. please mention your choice when ordering
- Frame with coating in the standard colors RAL 9004 (black), RAL 9010 (white), Sikkens C4.40.30 (red), F6.05.50 (taupe) or E4.40.40 (caramel). Alternative colors are available on request
- cockpit inside front: width 47 cm, back: 38 cm, seat depth 48 cm, height of armrest 68 cm.

- **NEW** from the date of this price list we take care of the purchase of the fabrics from fabric manufacturer KVADRAT. For prices including fabric and upholstery, consult the table next to it. Clearly indicate on the order which fabric name, color number and fabric group it concerns.

- the amount of fabric is determined by the number of chairs:
1 chair 1,90 m | 4 chairs 6,30 m
2 chairs 3,15 m | 5 chairs 8,20 m
3 chairs 5,05 m | 6 chairs 9,15 m
- mentioned fabric prices Kvadrat are based on 1 chair
- COM excludes fabric, including upholstery.
- choice of other fabric types Kvadrat is also possible. Please indicate the fabric choice and number clearly on the order.
- other fabric brands: send in fabric and calculate price based on linen price and indicated fabric meterage

KVADRAT fabrics

- Fabric group A:
- Fabric group B: Canvas, Naveli, Remix
- Fabric group C: Mizmaze, Moss, Re-wool
- Fabric group D: Safire, Steelcut Trio, Zero
- Fabric group E: Cifrado, Hallingdal
- Fabric group F: Coda, Rumor

GRETA chair

design: Gjalt Pilat, 2005

prices 2024 in euro excl. VAT

no customization possible

dimensions

W x D x H

Greta chair

45 x 54,5 x 82



light elm

695

oak

764

walnut

840

key features / additional prices

- seat height 45 cm
- Finishing possibilities according to the solid wood samples as presented in a current sample box
- The prices are the same for all finishes; soap, oil, stain-lacquer, transparent lacquer and color lacquer.

HITOSHI chair

design: Bart Vos, 2022

prices 2024 in euro excl. VAT

no customization possible

dimensions

W x D x H

Hitoshi chair

56 x 62 x 87

Hitoshi chair in leather
(including leather)

Hitoshi chair own fabric
excluding fabric
including upholstery

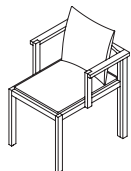

oak

walnut

key features / additional prices

KVADRAT

FABRICS

A

B

C

D

E

F

791

827

899

939

921

957

929

965

951

987

964

1.000

1.049

1.086

- width 56 cm, depth 62 cm, height 87 cm
- armrest height 70 cm
- possible leathers: Ohman Nero, Dark Brown, Havana furthermore sheepskin leather light brown, dark brown and black.

• **NEW** from the date of this price list we take care of the purchase of the fabrics from fabric manufacturer KVADRAT. For prices including fabric and upholstery, consult the table next to it. Clearly indicate on the order which fabric name, color number and fabric group it concerns.

- COM excludes fabric, including upholstery.
- required fabric: 1 meter for 1 chair
- required fabric becomes determined by number of chairs:
 - 2 chairs 1,70 m
 - 4 chairs 3,40 m
 - 6 chairs 5,10 m
- mentioned fabric prices Kvadrat are based on 1 chair
- choice of other fabric types Kvadrat is also possible. Please indicate the fabric choice and number clearly on the order.
- other fabric brands: send in fabric and calculate price based on linen price and indicated fabric meterage
- The finishing options are according to the solid wood samples such as presented in the current sample box.
- The prices are the same for all finishes; soap, oil, stain-lacquer, transparent lacquer and color lacquer.

KVADRAT fabrics

- Fabric group A:
- Fabric group B: Canvas, Naveli, Remix
- Fabric group C: Mizmaze, Moss, Re-wool
- Fabric group D: Safire, Steelcut Trio, Zero
- Fabric group E: Cifrado, Hallingdal
- Fabric group F: Coda, Rumor

LUDY armchair

design: Gjalt Pilat, 2019

prices 2024 in euro excl. VAT

no customization possible

dimensions

W x D x H

Ludy armchair

80 x 78 x 71



including leather
including upholstery

KVADRAT

FABRICS

A

B

C

D

E

F

**cow
leather**

**sheep
leather**

**customers
own
material**

*fabric
required*

1.583

1.250

1,3 meters

1.417

1.428

1.457

1.473

1.585

key features / additional prices

- seat height approx. 40 cm, net seat depth approx. 50 cm, armrest height approx. 62 cm
- possible cow leathers: Ohmann Nero, Dark Brown, Havana, furthermore sheep leathers: light brown, dark brown and black
- stitching in three possible colours; black, brown or sand colour. please mention your choice when ordering
- COM (customers own material) excludes fabric and includes upholstery

• **NEW** from the date of this price list we take care of the purchase of the fabrics from fabric manufacturer KVADRAT. For prices including fabric and upholstery, consult the table next to it. Clearly indicate on the order which fabric name, color number and fabric group it concerns.

- choice of other fabric types Kvadrat is also possible. Please indicate the fabric choice and number clearly on the order.
- other fabric brands: send in fabric and calculate price based on linen price and indicated fabric meterage
- Frame with coating in the standard colors RAL 9004, RAL 9010, Sikkens C4.40.30 or F6.05.50. Alternative colors are available on request
- frame solid steel 2 x 2 cm
- supplied with glides and felts
- armrests made of wood
- finishing possibilities according to the solid wood samples as presented in a current sample box
- The prices are the same for all finishes; soap, oil, stain-lacquer, transparent lacquer and color lacquer.

KVADRAT fabrics

- Fabric group A:
- Fabric group B: Canvas, Naveli, Remix
- Fabric group C: Mizmaze, Moss, Re-wool
- Fabric group D: Safire, Steelcut Trio, Zero
- Fabric group E: Cifrado, Hallingdal
- Fabric group F: Coda, Rumor

LUTSKE chair

design: Gjal't Pilat, 1997

prices 2024 in euro excl. VAT

no customization possible

dimensions

W x D x H

Lutske chair

41,5 x 49,5 x 85



light elm

559

oak

615

walnut

676

key features / additional prices

- seat height 46 cm
- Standard color of the steel parts:
- RAL 9004. A coating in another RAL or Sikkens color is possible. Please indicate the color choice when ordering.
- finishing possibilities according to the solid wood samples as presented in a current sample box
- The prices are the same for all finishes; soap, oil, stain-lacquer, transparent lacquer and color lacquer.

PAS chair

design: Gjalt Pilat, 2014

prices 2024 in euro excl. VAT

no customization possible

dimensions

W x D x H

Pas chair

49 x 59 x 72,5

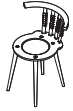

light elm

462

oak

508

walnut

559

key features / additional prices

- height of seat: 46,5 cm
- finishing possibilities according to the solid wood samples as presented in a current sample box
- The prices are the same for all finishes; soap, oil, stain-lacquer, transparent lacquer and color lacquer.
- in addition, a combination of color and transparent lacquer is possible, in which chair legs and bottom of the seat are spraypainted in color and the top of the seat and the back are spraypainted transparently.

SYL stool

design: Bas van der Veer, 2015

prices 2024 in euro excl. VAT

no customization possible

dimensions

Ø x H

light elm

oak

walnut

key features / additional prices

Syl stool

Ø 30 x 45

291

321

353

- finishing possibilities according to the solid wood samples as presented in a current sample box
- The prices are the same for all finishes; soap, oil, stain-lacquer, transparant lacquer and color lacquer.



SYTO stool

design: Gjalt Pilat, 2021

prices 2024 in euro excl. VAT

no customization possible

dimensions

Ø x H

light elm

oak

walnut

key features / additional prices

Syto stool

Ø35 x 46

300

330

363

- seat thickness 4 cm
- finishing possibilities according to the solid wood samples as presented in a current sample box
- The prices are the same for all finishes; soap, oil, stain-lacquer, transparent lacquer and color lacquer.



CABINETS SIDEBOARDS SHELVING UNITS

prices 2024 in euro excl. VAT



BEREND
cabinet series
page 78-85

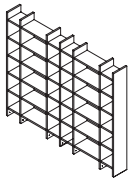

EDWARD
shelving unit
page 86

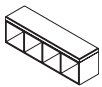

EIRIK
shelving unit
page 87

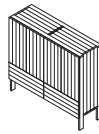

ELFRIEDE
cabinet
page 88-89



ELFRIEDE
cabinet on frame
page 90-91

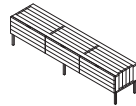

ELFRIEDE
sideboard
page 92-93

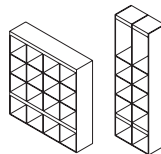

HOTZE
shelving unit
page 94

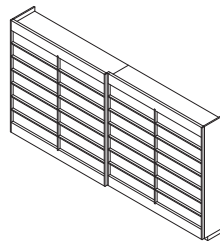

JAAP
cabinet
page 95

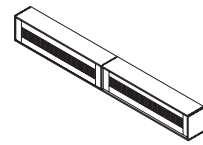

MEINT
hanging
sideboard
page 96

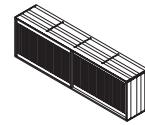

MEINT REIN
sideboard
page 97-98



STIJN
shelving unit
page 99

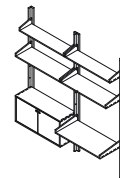

OLE
shelving
system
page 100-105

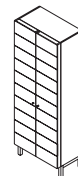

0208 SYM
cabinet
page 106

BEREND cabinet series

design: Gjalt Pilat, 2023

prices 2024 in euro excl. VAT

no customization possible
dimensions **W x D x H**

body
 example: 23cm high,
 3 compartments wide

base
 example: low model 30 cm,
 1320 wide (3 compartments)

complete

indication of the
 (start) position of the body

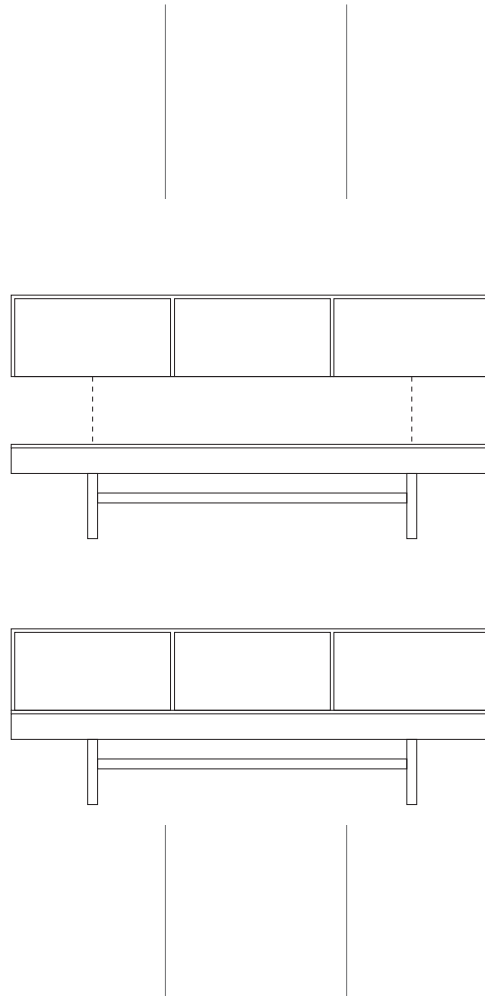

key features / additional prices

- a Berend cabinet can be composed using 2 different parts:
- 2 heights base frames:**
 low: 300 mm or high: 500 mm
- 3 heights of body parts:**
 1 = 230 mm high (equipped with flaps),
 2 = 440 mm (equipped with doors)
 3 = 865 mm high (equipped with doors)
- sizes and prices of the various width measurements made insightful on the next 5 pages
- finishing possibilities according to the solid wood samples as presented in a current sample box
- the prices are the same for all finishes; soap, oil, stain-lacquer, transparant lacquer and color lacquer.

To order

- in addition to the chosen wood type and finish we require the following information for proper order processing:
 1. width of the Base (number of compartments)
 2. height of the Base (300/500mm)
 3. width of the body (number of compartments)
 4. height of the body (230/440/865mm)
 5. position where cabinet body should start
 6. by default, the wooden part of the base is not in the color of the steel frame. Entire base in one color? Then indicate this when ordering.
 7. For body heights 440 and 865 indicate how the doors should open, left-handed or right-handed. Indicate with the following symbols:

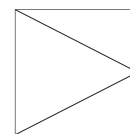

opens to the left

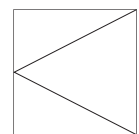

opens to the right

BEREND base 30 cm high

design: Gjalt Pilat, 2023

prices 2024 in euro excl. VAT

no customization possible

dimensions

W x D x H

Berend cabinet base LOW
300 MM HIGH



base 2 compartments wide 890 x 400 x 300



base 3 compartments wide 1320 x 400 x 300

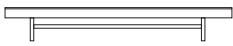

base 4 compartments wide 1750 x 400 x 300



base 5 compartments wide 2180 x 400 x 300



base 6 compartments wide 2610 x 400 x 300



base 7 compartments wide 3040 x 400 x 300

beech

light elm

oak

walnut

key features / additional prices

963

1.059

1.079

1.117

1.229

1.253

1.248

1.373

1.399

1.431

1.574

1.604

1.619

1.781

1.815

1.777

1.955

1.992

- the base is constructed from a steel frame with a wooden top
- by default the wooden part of the base is not sprayed in the same color of the frame.
- if the wooden part of the base has to be spraypainted in the same color as the steel frame, please indicate this separately when ordering
- base with coating in the standard colors RAL 9004 (black), RAL 9010 (white), Sikkens C4.40.30 (red), F6.05.50 (taupe) or E4.40.40 (caramel). Alternative colors are possible on request
- a base of 7 compartments wide stands on 6 feet
- finishing possibilities according to the solid wood samples as presented in a current sample box
- the prices are the same for all finishes; soap, oil, stain-lacquer, transparent lacquer and color lacquer.

BEREND base 50 cm high

design: Gjalt Pilat, 2023

prices 2024 in euro excl. VAT

no customization possible

dimensions

W x D x H

Berend base HIGH
500 MM HIGH

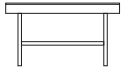

base 2 compartments wide 890 x 400 x 500



base 3 compartments wide 1320 x 400 x 500

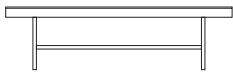

base 4 compartments wide 1750 x 400 x 500

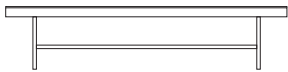

base 5 compartments wide 2180 x 400 x 500

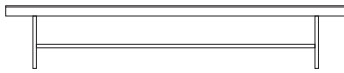

base 6 compartments wide 2610 x 400 x 500

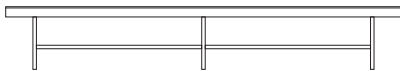

base 7 compartments wide 3040 x 400 x 500

beech

light elm

oak

walnut

key features / additional prices

963

1.059

1.079

1.117

1.229

1.253

1.248

1.373

1.399

1.431

1.574

1.604

1.619

1.781

1.815

1.777

1.955

1.992

- the base is constructed from a steel frame with a wooden top
- by default the wooden part of the base is not sprayed in the same color of the frame.
- if the wooden part of the base has to be spraypainted in the same color as the steel frame, please indicate this separately when ordering
- base with coating in the standard colors RAL 9004 (black), RAL 9010 (white), Sikkens C4.40.30 (red), F6.05.50 (taupe) or E4.40.40 (caramel). Alternative colors are possible on request
- a base of 7 compartments wide stands on 6 feet
- finishing possibilities according to the solid wood samples as presented in a current sample box
- the prices are the same for all finishes; soap, oil, stain-lacquer, transparent lacquer and color lacquer.

BEREND body 23 cm high

design: Gjalt Pilat, 2023

prices 2024 in euro excl. VAT

no customization possible

dimensions

W x D x H

Berend body with flaps
230 MM HIGH



1 compartment wide 460 x 400 x 230



2 compartments wide 890 x 400 x 230



3 compartments wide 1320 x 400 x 230



4 compartments wide 1750 x 400 x 230



5 compartments wide 2180 x 400 x 230



6 compartments wide 2610 x 400 x 230



7 compartments wide 3040 x 400 x 230

beech

light elm

oak

walnut

key features / additional prices

- body elements with flaps
- net depth in the compartments: 35.5 cm
- finishing possibilities according to the solid wood samples as presented in a current sample box
- the prices are the same for all finishes; soap, oil, stain-lacquer, transparent lacquer and color lacquer.



flap(s) open downwards

BEREND body 44 cm high

design: Gjalt Pilat, 2023

prices 2024 in euro excl. VAT

no customization possible

dimensions

W x D x H

Berend body with doors

440 MM HIGH



1 compartment wide 460 x 400 x 440



2 compartments wide 890 x 400 x 440



3 compartments wide 1320 x 400 x 440



4 compartments wide 1750 x 400 x 440



5 compartments wide 2180 x 400 x 440



6 compartments wide 2610 x 400 x 440



7 compartments wide 3040 x 400 x 440

beech

light elm

oak

walnut

key features / additional prices

- body elements with doors
- net depth in the compartments: 35.5 cm
- finishing possibilities according to the solid wood samples as presented in a current sample box
- the prices are the same for all finishes; soap, oil, stain-lacquer, transparent lacquer and color lacquer.

- When ordering, indicate how the doors must open, left-handed or right-handed.

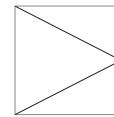

to the left

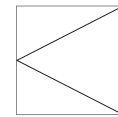

to the right

1.006

1.106

1.217

1.392

1.531

1.684

1.828

2.011

2.212

2.362

2.598

2.858

3.021

3.323

3.656

3.753

4.129

4.542

4.496

4.946

5.440

BEREND body 86,5 cm high

design: Gjalt Pilat, 2023

prices 2024 in euro excl. VAT

no customization possible

dimensions

W x D x H

Berend body with doors
865 MM HIGH



1 compartment wide 460 x 400 x 865

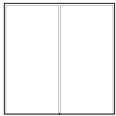

2 compartments wide 890 x 400 x 865



3 compartments wide 1320 x 400 x 865



4 compartments wide 1750 x 400 x 865



5 compartments wide 2180 x 400 x 865



6 compartments wide 2610 x 400 x 865



7 compartments wide 3040 x 400 x 865

beech

light elm

oak

walnut

key features / additional prices

- body elements with doors
- net depth in the compartments: 35.5 cm
- finishing possibilities according to the solid wood samples as presented in a current sample box
- the prices are the same for all finishes; soap, oil, stain-lacquer, transparent lacquer and color lacquer.
- When ordering, indicate how the doors must open, left-handed or right-handed.

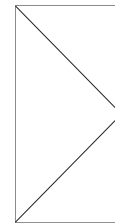

to the left

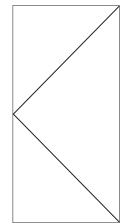

to the right

1.251

1.377

1.514

1.720

1.892

2.081

2.218

2.439

2.683

2.830

3.113

3.424

3.638

4.002

4.402

4.521

4.973

5.471

5.401

5.941

6.535

BEREND cabinet series examples

design: Gjalt Pilat, 2023

prices 2024 in euro excl. VAT

no customization possible

dimensions **W x D x H**

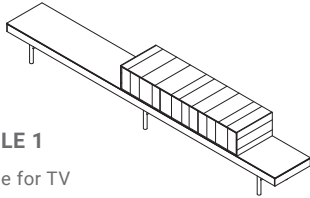

EXAMPLE 1
side table for TV

total dimensions 3040 x 400 x 530

To order as:

1. width of base 3040 (7 compartments)
2. height base 300
3. body 1320 wide (3 compartments)
4. body 230 high
5. body starting on position 4
6. base in one color: yes

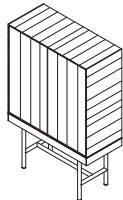

EXAMPLE 2

cabinet

total dimensions 890 x 400 x 1365

To order as:

1. width of base 890 (2 compartments)
2. height base 500
3. body 890 wide (2 compartments)
4. body 865 high
5. body starting on position 1
6. base in one color: no
7. door 1: left, door 2: right

beech	light elm	oak	walnut
-------	-----------	-----	--------

BASE	BASE	BASE	BASE
1.777	1.955	1.992	1.992
BODY	BODY	BODY	BODY
1.482	1.630	1.793	1.793
TOTAL	TOTAL	TOTAL	TOTAL
3.259	3.585	3.785	3.785

BASE	BASE	BASE	BASE
963	1.059	1.079	1.079
BODY	BODY	BODY	BODY
1.720	1.892	2.081	2.081
TOTAL	TOTAL	TOTAL	TOTAL
2.683	2.951	3.160	3.160

key features / additional prices

- in addition to the chosen wood type and finish we require the following information for proper order processing:
 1. width of the base (number of compartments)
 2. height of the base (300/500mm)
 3. width of the body (number of compartments)
 4. height of the body (230/440/865mm)
 5. position where cabinet body should start
 6. by default, the wooden part of the base is not in the color of the steel frame. Entire base in one color? Then indicate this when ordering.
 - 7. For body heights 440 and 865 indicate how the doors should open, left-handed or right-handed. Indicate with the following symbols:

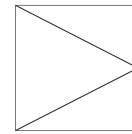

opens to the left

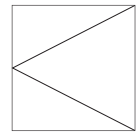

opens to the right

- Beside are some price examples including order formulation

BEREND cabinet series examples

design: Gjalt Pilat, 2023

prices 2024 in euro excl. VAT

no customization possible

dimensions

W x D x H

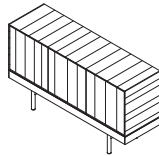

EXAMPLE 3

sideboard

total dimensions 1320 x 400 x 740

To order as:

1. width of base 1320 (3 compartments)
2. height base 300
3. body 1320 wide (3 compartments)
4. body 440 high
5. body starting on position 1
6. base in one color: yes
7. door 1: left, door 2: left, door 3: to the right.

beech

light elm

oak

walnut

	light elm	oak	walnut
BASE	1.117	1.229	1.253
BODY	1.828	2.011	2.212
TOTAL	2.945	3.240	3.465

key features / additional prices

- in addition to the chosen wood type and finish we require the following information for proper order processing:
 1. width of the base (number of compartments)
 2. height of the base (300/500mm)
 3. width of the body (number of compartments)
 4. height of the body (230/440/865mm)
 5. position where cabinet body should start
 6. by default, the wooden part of the base is not in the color of the steel frame. Entire base in one color? Then indicate this when ordering.
 7. For body heights 440 and 865 indicate how the doors should open, left-handed or right-handed. Indicate with the following symbols:

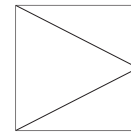

opens to the left

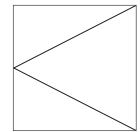

opens to the right

- Beside are some price examples including order formulation

EDWARD shelving unit

design: Gjalt Pilat, 2017 / 2022

prices 2024 in euro excl. VAT

no customization possible

Edward compartments

Edward uprights

3 x 33 x 147

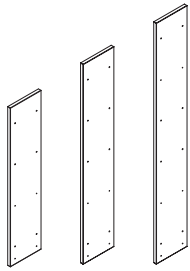

3 x 33 x 185

3 x 33 x 223

Edward shelf 30 width

30 x 32 x 3



Edward shelf 63 width

63 x 32 x 3



Edward shelving unit

price example

267 x 33 x 185

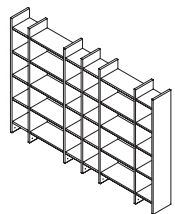

compartment

wood type

price

amount

sub total

upright 185

light elm

307

7

2.149

shelf 30

light elm

87

20

1.740

shelf 63

light elm

122

10

1.220

total

5.109

Edward shelving unit

price example

102 x 33 x 223

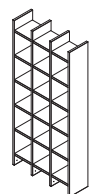

compartment

wood type

price

amount

sub total

upright 223

MDF

328

4

1.312

shelf 30

MDF

80

18

1.440

total

2.752

key features / additional prices





- Height 147, 185 or 223 cm
- Shelves and uprights 3 cm thick
- Width shelves 30 or 63 cm
- Standard height between the shelves is 35 cm
- finishing possibilities according to the solid wood samples as presented in a current sample box
- The prices are the same for all finishes; soap, oil, stain-lacquer, transparent lacquer and color lacquer.

EIRIK cupboard/shelving unit

design: Peter Tromop, 2007

prices 2024 in euro excl. VAT

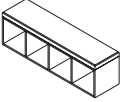
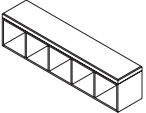
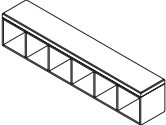
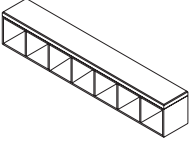
custom sizes on request

dimensions	W x D x H	light elm	oak	walnut	key features / additional prices
	30 x 30 x 34,5	369	406	447	• 2 x wall mount, additional price 33,- euro
	58,5 x 30 x 34,5	566	622	685	• 2 x wall mount, additional price 33,- euro
	87 x 30 x 34,5	763	840	924	• 2 x wall mount, additional price 33,- euro
	115,5 x 30 x 34,5	962	1.058	1.164	• 3 x wall mount, additional price 46,- euro
	144 x 30 x 34,5	1.159	1.275	1.403	• 3 x wall mount, additional price 46,- euro
	172,5 x 30 x 34,5	1.356	1.492	1.641	• 4 x wall mount, additional price 60,- euro
	201 x 30 x 34,5	1.555	1.711	1.882	• 4 x wall mount, additional price 60,- euro
	Eirik cupboard doors per compartment	100	110	121	

- Eirik cupboard / shelving unit is supplied as standard on felt, for wall mounting the above-mentioned surcharge applies
- doors are suitable for the models on this page
- finishing possibilities according to the solid wood samples as presented in a current sample box
- The prices are the same for all finishes; soap, oil, stain-lacquer, transparent lacquer and color lacquer.

ELFRIEDE cabinet/sideboard

design: Gjalt Pilat / Peter Tromop 2018

prices 2024 in euro excl. VAT

no customization possible

dimensions

W x D x H

beech

light elm

oak

walnut

key features / additional prices

1 compartment wide,
2 compartments
high



66 x 39,5 x 70,5
66 x 46 x 70,5
66 x 53 x 70,5

1.494
1.517
1.628

1.643
1.669
1.791

1.807
1.835
1.970

- the mentioned depth is that of the body
- the lower shelf is fixed to the body, other shelves are height-adjustable
- height of legs is 20 cm, equipped with adjustable legs
- completely made of 2,2 cm thick wood
- drawer boxes sizes: approx. 58 x 31 x 14 cm,
- color anthracite. drawers are push to open, fully extendable and can only be placed in bottom position.
- doors with cup handles on top
- prices include rear wall
- finishing possibilities according to the solid wood samples as presented in a current sample box
- The prices are the same for all finishes; soap, oil, stain-lacquer, transparent lacquer and color lacquer.

1 compartment wide,
3 compartments
high

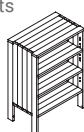

66 x 39,5 x 95
66 x 46 x 95
66 x 53 x 95

1.560
1.605
1.722

1.716
1.766
1.894

1.887
1.943
2.083

1 compartment wide,
4 compartments
high

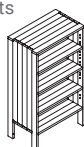

66 x 39,5 x 119
66 x 46 x 119
66 x 53 x 119

1.626
1.695
1.815

1.789
1.864
1.996

1.967
2.051
2.196

2 compartments wide,
2 compartments
high

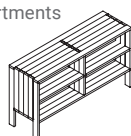

130 x 39,5 x 70,5
130 x 46 x 70,5
130 x 53 x 70,5

1.841
1.876
1.970

2.025
2.064
2.167

2.227
2.270
2.384

2 compartments wide,
3 compartments
high

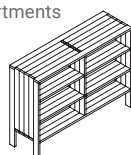

130 x 39,5 x 95
130 x 46 x 95
130 x 53 x 95

1.940
1.998
2.106

2.134
2.198
2.317

2.347
2.417
2.548

2 compartments wide,
4 compartments
high

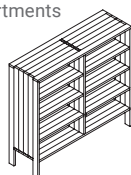

130 x 39,5 x 119
130 x 46 x 119
130 x 53 x 119

2.047
2.127
2.244

2.252
2.339
2.468

2.477
2.573
2.715

drawer unit
price



234

258

283

doors price
per set



2 compartments high
3 compartments high
4 compartments high

287
307
327

316
338
360

347
372
396

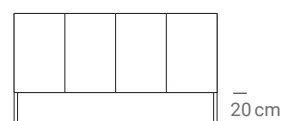

ELFRIEDE cabinet/sideboard

design: Gjal't Pilat / Peter Tromop 2018

prices 2024 in euro excl. VAT

no customization possible

dimensions

W x D x H

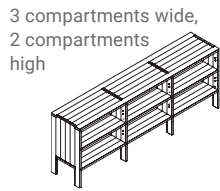

3 compartments wide, 2 compartments high	193,5 x 39,5 x 70,5
	193,5 x 46 x 70,5
	193,5 x 53 x 70,5

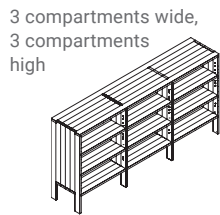

3 compartments wide, 3 compartments high	193,5 x 39,5 x 95
	193,5 x 46 x 95
	193,5 x 53 x 95

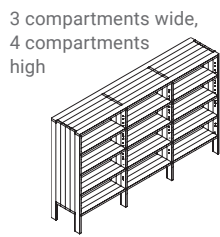

3 compartments wide, 4 compartments high	193,5 x 39,5 x 119
	193,5 x 46 x 119
	193,5 x 53 x 119



Elfriede 4 vakken breed, 2 vakken hoog	257,5 x 39,5 x 70,5
	257,5 x 46 x 70,5
	257,5 x 53 x 70,5

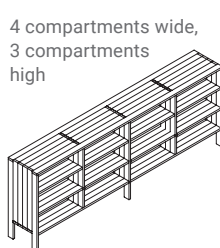

4 compartments wide, 3 compartments high	257,5 x 39,5 x 95
	257,5 x 46 x 95
	257,5 x 53 x 95

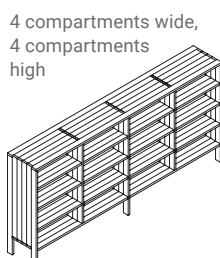

4 compartments wide, 4 compartments high	257,5 x 39,5 x 119
	257,5 x 46 x 119
	257,5 x 53 x 119



drawer unit price

	234	258	283
--	-----	-----	-----



doors price per set

2 compartments high	287	316	347
3 compartments high	307	338	372
4 compartments high	327	360	396

beech

light elm

oak

walnut

key features / additional prices

- the mentioned depth is that of the body
- the lower shelf is fixed to the body, other shelves are height-adjustable
- height of legs is 20 cm, equipped with adjustable legs
- completely made of 2,2 cm thick wood
- drawer boxes sizes: approx. 58 x 31 x 14 cm,
- color anthracite. drawers are push to open, fully extendable and can only be placed in bottom position.
- doors with cup handles on top
- prices include rear wall
- finishing possibilities according to the solid wood samples as presented in a current sample box
- The prices are the same for all finishes; soap, oil, stain-lacquer, transparant lacquer and color lacquer.

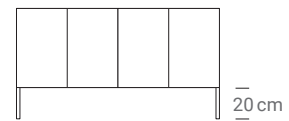

ELFRIEDE cabinet/sideboard on frame

design: Gjalt Pilat / Peter Tromop 2018

prices 2024 in euro excl. VAT

no customization possible

dimensions

W x D x H

beech

light elm

oak

walnut

key features / additional prices

1 compartment wide,
2 compartments
high



66 x 39,5 x 95,5
66 x 46 x 95,5
66 x 53 x 95,5

1.770
1.794
1.905

1.947
1.973
2.095

2.142
2.171
2.305

- the mentioned depth is that of the body
- the lower shelf is fixed to the body, other shelves are height-adjustable
- completely made of 2,2 cm thick wood
- drawer boxes sizes: approx. 58 x 31 x 14 cm, color anthracite. drawers are push to open, fully extendable and can only be placed in bottom position.
- doors with cup handles on top
- prices include rear wall
- finishing possibilities according to the solid wood samples as presented in a current sample box
- The prices are the same for all finishes; soap, oil, stain-lacquer, transparent lacquer and color lacquer.
- a metal frame has a height of 45 cm
- metal feet are adjustable
- Frame with coating in the standard colors RAL 9004 (black), RAL 9010 (white), Sikkens C4.40.30 (red), F6.05.50 (taupe) or E4.40.40 (caramel). Alternative colors are available on request

1 compartment wide,
3 compartments
high

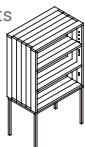

66 x 39,5 x 120
66 x 46 x 120
66 x 53 x 120

1.849
1.874
1.991

2.034
2.062
2.190

2.238
2.268
2.409

1 compartment wide,
4 compartments
high

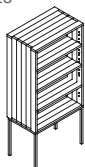

66 x 39,5 x 144
66 x 46 x 144
66 x 53 x 144

1.933
1.959
2.080

2.126
2.154
2.288

2.338
2.370
2.517

2 compartment wide,
2 compartments
high

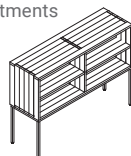

130 x 39,5 x 95,5
130 x 46 x 95,5
130 x 53 x 95,5

2.224
2.261
2.353

2.446
2.487
2.588

2.691
2.735
2.847

2 compartment wide,
3 compartments
high

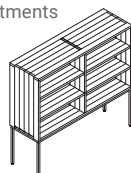

130 x 39,5 x 120
130 x 46 x 120
130 x 53 x 120

2.324
2.382
2.490

2.557
2.620
2.739

2.812
2.882
3.013

2 compartment wide,
4 compartments
high

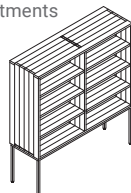

130 x 39,5 x 144
130 x 46 x 144
130 x 53 x 144

2.430
2.511
2.628

2.674
2.762
2.891

2.941
3.038
3.180

drawer unit
price



234

258

283

doors price
per set



2 vakken hoog
3 vakken hoog
4 vakken hoog

287
307
327

316
338
360

347
372
396

• METAL FRAME 4 LEGS (with width 130)

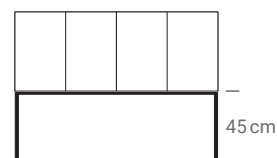

• METAL FRAME 6 LEGS (with width 257.5)

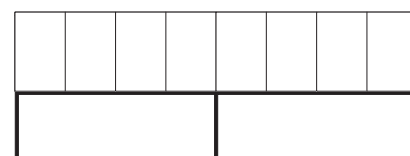

ELFRIEDE cabinet/sideboard on frame

design: Gjalt Pilat / Peter Tromop 2018

prices 2024 in euro excl. VAT

no customization possible

dimensions

W x D x H

3 compartment wide,
2 compartments
high

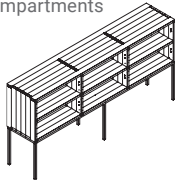

193,5 x 39,5 x 95,5

193,5 x 46 x 95,5

193,5 x 53 x 95,5

3 compartment wide,
3 compartments
high

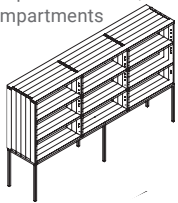

193,5 x 39,5 x 120

193,5 x 46 x 120

193,5 x 53 x 120

3 compartment wide,
4 compartments
high

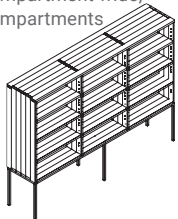

193,5 x 39,5 x 144

193,5 x 46 x 144

193,5 x 53 x 144

4 compartment wide
2 compartments
high

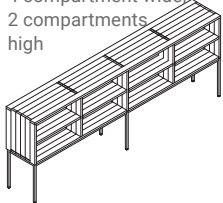

257,5 x 39,5 x 95,5

257,5 x 46 x 95,5

257,5 x 53 x 95,5

4 compartment wide,
3 compartments
high

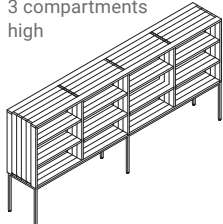

257,5 x 39,5 x 120

257,5 x 46 x 120

257,5 x 53 x 120

4 compartment wide,
4 compartments
high

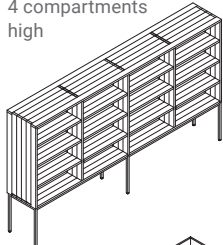

257,5 x 39,5 x 144

257,5 x 46 x 144

257,5 x 53 x 144

drawer unit
price



234

258

283

doors price
per set



2 vakken hoog

287

316

347

3 vakken hoog

307

338

372

4 vakken hoog

327

360

396

beech

light elm

oak

walnut

key features / additional prices

- the mentioned depth is that of the body
- the lower shelf is fixed to the body, other shelves are height-adjustable
- completely made of 2,2 cm thick wood
- drawer boxes sizes: approx. 58 x 31 x 14 cm, color anthracite. drawers are push to open, fully extendable and can only be placed in bottom position.
- doors with cup handles on top
- prices include rear wall
- finishing possibilities according to the solid wood samples as presented in a current sample box
- The prices are the same for all finishes; soap, oil, stain-lacquer, transparent lacquer and color lacquer.
- a metal frame has a height of 45 cm
- metal feet are adjustable
- Frame with coating in the standard colors RAL 9004 (black), RAL 9010 (white), Sikkens C4.40.30 (red), F6.05.50 (taupe) or E4.40.40 (caramel). Alternative colors are available on request

• METAL FRAME 4 LEGS (with width 130)

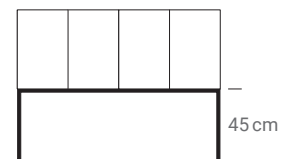

• METAL FRAME 6 LEGS (with width 257.5)



ELFRIEDE wall table

design: Gjalt Pilat / Peter Tromop 2023

prices 2024 in euro excl. VAT

custom sizes on request

dimensions

W x D x H

Elfriede wall table

1 compartment wide

60 x 39,5 x 46,4

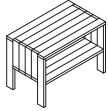

Elfriede wall table

2 compartments wide

130 x 39,5 x 46,4

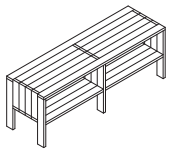

Elfriede wall table

3 compartments wide

193,5 x 39,5 x 46,4

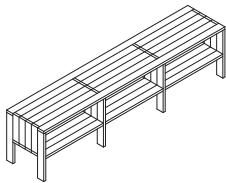

Elfriede wall table

4 compartments wide

257,5 x 39,5 x 46,4

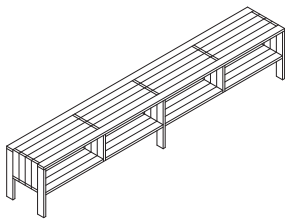

Elfriede wall table flap

65,6 x 26,4 x 22



beech

light elm

oak

walnut

key features / additional prices

1.330

1.463

1.609

- the mentioned depth is that of the body
- height of legs is 20 cm, equipped with adjustable legs
- completely made of 2,2 cm thick wood
- flaps with cup handles on top
- prices include rear wall
- finishing possibilities according to the solid wood samples as presented in a current sample box
- The prices are the same for all finishes; soap, oil, stain-lacquer, transparent lacquer and color lacquer.

1.630

1.793

1.972

1.925

2.118

2.330

2.268

2.495

2.744

195

214

236

ELFRIEDE wall table on frame

design: Gjal't Pilat / Peter Tromop 2023

prices 2024 in euro excl. VAT

custom sizes on request

dimensions

W x D x H

beech

light elm

oak

walnut

key features / additional prices

Elfriede wall table

on frame

60 x 39,5 x 46,4

1.640

1.804

1.985

1 compartment wide

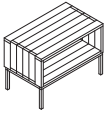

Elfriede wall table

on frame

130 x 39,5 x 46,4

2.066

2.272

2.500

2 compartments wide

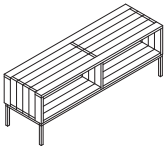

Elfriede wall table

on frame

193,5 x 39,5 x 46,4

2.509

2.760

3.036

3 compartments wide

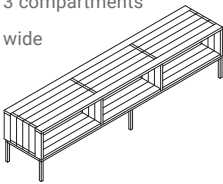

Elfriede wall table

on frame

257,5 x 39,5 x 46,4

2.931

3.224

3.547

4 compartments wide

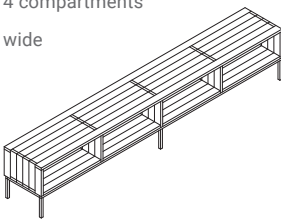

Elfriede wall table flap

65,6 x 26,4 x 22

195

214

236



- the mentioned depth is that of the body
- completely made of 2,2 cm thick wood
- flaps with cup handles on top
- prices include rear wall
- a metal frame has a height of 20 cm
- metal feet are adjustable
- Frame with coating in the standard colors RAL 9004 (black), RAL 9010 (white), Sikkens C4.40.30 (red), F6.05.50 (taupe) or E4.40.40 (caramel). Alternative colors are available on request
- finishing possibilities according to the solid wood samples as presented in a current sample box
- The prices are the same for all finishes; soap, oil, stain-lacquer, transparent lacquer and color lacquer.

HOTZE shelving unit

design: Gjalt Pilat, 2002/2010

prices 2024 in euro excl. VAT

custom sizes on request

dimensions

W x D x H

Hotze shelving unit 63 x 30 x 197

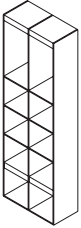

125 x 30 x 135

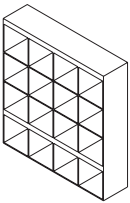

additional price door 30 x 30

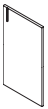

additional price door 30 x 61

beech

light elm

oak

walnut

mdf

key features / additional prices

1.462

1.608

1.768

2.342

2.576

2.834

- material thickness 1/6 cm
- wall mounting by means of a mounting rail that is included
- at a Hotze sprayed in a color, based on the beech/light elm price
- doors MDF sprayed in epoxy lacquer in a RAL or Sikkens colour, except metallics and fluorescent paints
- doors 1,9 cm thick, MDF spraypainted in a colour of your choice
- The finishing options are according to the solid wood samples such as presented in the current sample box.
- The prices are the same for all finishes; soap, oil, stain-lacquer, transparant lacquer and color lacquer.

147

221

JAAP cabinet

design: Gjalt Pilat, 2004

prices 2024 in euro excl. VAT

custom sizes on request

dimensions

W x D x H

light elm

oak

walnut

key features / additional prices

Jaap cabinet 240

240 x 42 x 192

8.626

9.489

10.437

(completely solid wood)

240 x 42 x 192

6.628

7.291

8.020

(body mdf)

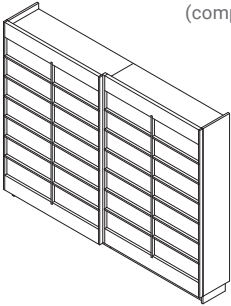

Jaap cabinet 300

300 x 42 x 192

10.035

11.038

12.142

(completely solid wood)

300 x 42 x 192

7.661

8.427

9.269

(body mdf)

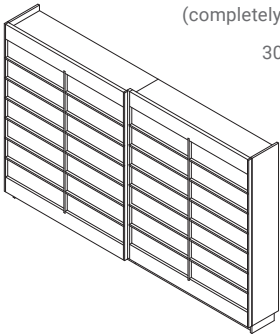

Jaap cabinet 345

345 x 42 x 192

10.460

11.506

12.657

(completely solid wood)

345 x 42 x 192

7.891

8.680

9.548

(body mdf)

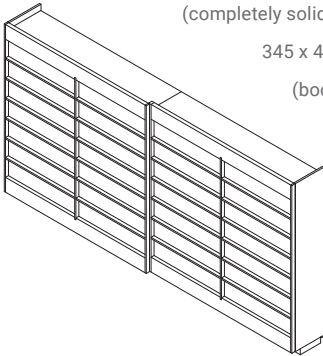

- frame sliding door solid wood, doorpanel and backpanel MDF spraypainted in a colour of choice
- depth of shelves 31,5 cm
- the Jaap cabinet is dismountable
- sliding doors have an integrated brake and closing system
- The finishing options are according to the solid wood samples such as presented in the current sample box.
- The prices are the same for all finishes; soap and / or oil, stain-lacquer, transparant lacquer and color lacquer.
- layout Jaap cabinet:

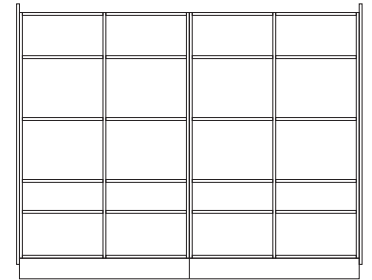

MEINT hanging sideboard

design: Gjalt Pilat, 2005

prices 2024 in euro excl. VAT

custom sizes on request

dimensions

W x D x H

Meint hanging sideboard	175 x 30 x 40
	225 x 30 x 40
	275 x 30 x 40
	325 x 30 x 40

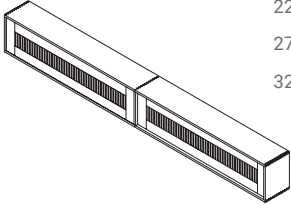

beech

light elm

oak

walnut

2.215	2.437	2.680
2.385	2.623	2.886
2.607	2.868	3.155
2.775	3.052	3.357

key features / additional prices

- sliding doors
- height adjustable shelves, depth of shelf 23 cm
- wall mounting by means of a mounting rail that is included
- The Meint hanging cabinet is hanging approx. 6 mm from the wall
- The finishing options are according to the solid wood samples such as presented in the current sample box.
- The prices are the same for all finishes; soap and / or oil, stain-lacquer, transparant lacquer and color lacquer.

MEINT REIN hanging sideboard

design: Gjalt Pilat, 2010

prices 2024 in euro excl. VAT

custom sizes on request

dimensions

W x D x H

light elm

oak

walnut

key features / additional prices

Meint Rein
hanging sideboard

212 x 40 x 64

4.537

4.991

5.490

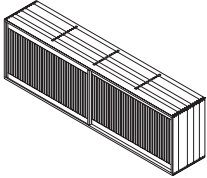

Meint Rein
hanging sideboard

266 x 40 x 64

4.865

5.351

5.886

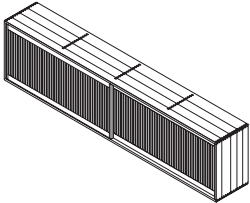

Meint Rein
hanging sideboard

320 x 40 x 64

5.193

5.713

6.284

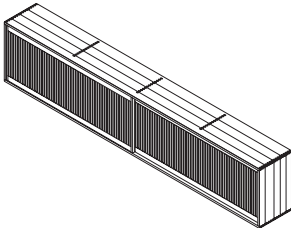

Meint Rein
hanging sideboard

374 x 40 x 64

5.522

6.074

6.681

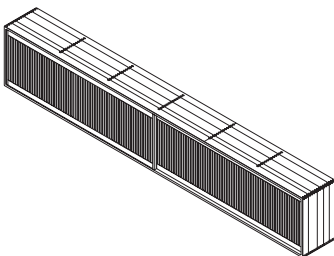

- the Meint Rein is available in 2 variations: as a hanging sideboard mounted on the wall and as a standing sideboard on a frame (see next page)
- The Meint Rein hanging cabinet is hanging approx. 6 mm from the wall
- height hull 64 cm
- 32 cm deep shelves are height adjustable, one behind every door
- The Meint Rein has an MDF back wall in RAL or Sikkens color of your choice.
- The finishing options are according to the solid wood samples such as presented in the current sample box.
- The prices are the same for all finishes; soap and / or oil, stain-lacquer, transparant lacquer and color lacquer.

MEINT REIN sideboard on frame

design: Gjalt Pilat, 2010

prices 2024 in euro excl. VAT

custom sizes on request

dimensions

W x D x H

light elm

oak

walnut

key features / additional prices

Meint Rein
sideboard on frame

212 x 40 x 84

5.320

5.852

6.438

- the Meint Rein is available in 2 variations: as a standing sideboard on a frame and as a hanging sideboard mounted on the wall (see page before)

- height hull 64 cm

- height frame 20 cm

- 32 cm deep shelves are height adjustable, one behind every door

- The Meint Rein has an MDF back wall in RAL or Sikkens color of your choice.

- Frame with coating in the standard colors RAL 9004 (black), RAL 9010 (white), Sikkens C4.40.30 (red), F6.05.50 (taupe) or E4.40.40 (caramel). Alternative colors are available on request

- The finishing options are according to the solid wood samples such as presented in the current sample box.

- The prices are the same for all finishes; soap and / or oil, stain-lacquer, transparent lacquer and color lacquer.

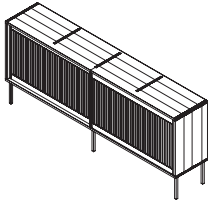

Meint Rein
sideboard on frame

266 x 40 x 84

5.716

6.288

6.917

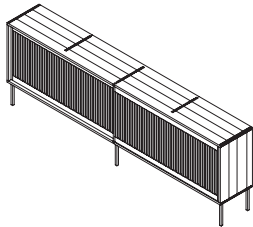

Meint Rein
sideboard on frame

320 x 40 x 84

6.117

6.729

7.401

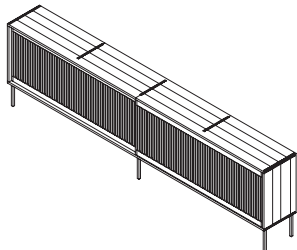

Meint Rein
sideboard on frame

374 x 40 x 84

6.509

7.160

7.876

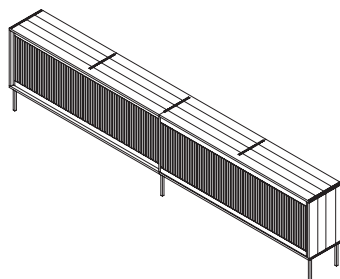

STIJN shelving units

design: Gjalt Pilat / Peter Tromop 2020

prijslijst 2024 in euro incl. 21% btw

no customization possible

afmetingen

B x D x H

Stijn basic panel

32 x 4 x 197

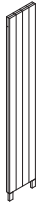

Stijn shelf
(standard/with accent)

32 x 32 x 4

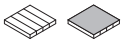

Stijn coat rack element
for 2 compartments

64 x 10 x 4



Stijn coat rack element
for 3 compartments

97 x 10 x 4



Wall socket (duo)

prijs per stuk

44



pricing example

compartment

wood type

price p/p.

amount

sub total

Stijn TV-wall-unit

basic panel

light elm

281

6

1.686

shelf

light elm

95

16

1.520

shelf with accent

light elm

95

8

760

coat rack element

-

-

-

-

wall socket

black

44

1

44

total

4.010

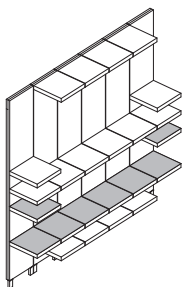

bijzonderheden / meerprijzen

- shelf with accent finish; no additional price
- coat rack element only possible per 2 panels and in combination with 2 shelves
- The finishing options are according to the solid wood samples such as presented in the current sample box.
- The prices are the same for all finishes; soap and / or oil, stain-lacquer, transparant lacquer and color lacquer.
- order form design drawing available via the dealer login on www.pilat.nl/en/login.
Look below Image Archive.

OLE shelving system

design: Studio Slow, 2024

prices 2024 in euro excl. VAT

no customization possible

example configuration

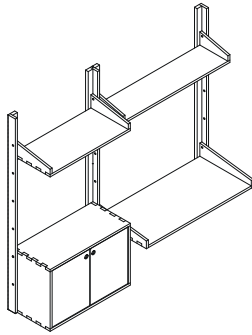

Basic components
OLE shelving system
using the example
shown above

beech
light elm oak walnut

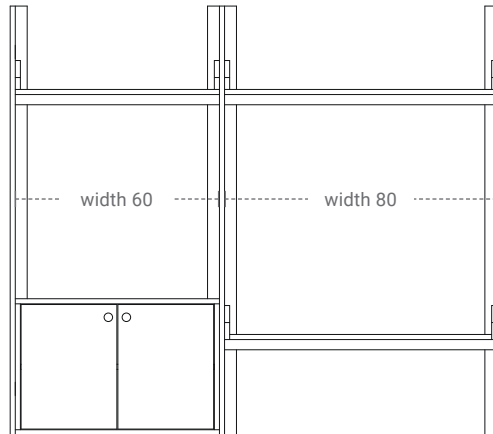

key features / additional prices

- To build an Ole shelving unit, 3 types of compartments are available; uprights, shelves and cabinets.
- Upright lengths 72 / 90 / 126 / 180 cm.
- Shelf widths 60 / 80 cm, available in depths 21 / 28 / 38.5 cm.
- Cabinet module widths 60 / 80 cm, depth 28 cm.
- Dimensions and prices of the different parts are made clear on the next 5 pages
- finishing options according to the solid wood samples as presented in a current sample box
- prices are the same for all finishes with soap/oil/lacquer/stain lacquer/coloured lacquer

When ordering

- for a proper processing of an order, in addition to the selected wood type and finish, we need the following information:
 1. height measurement of uprights (72/90/126/180)
 2. number of middle uprights
 3. number of shelves in desired width (60/80) + desired depth (21/28/38.5)
 4. number of cabinet modules + width (60/80)
 5. An order is accompanied by a clear sketch.

upright Left

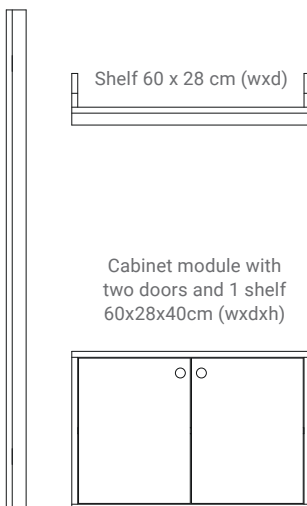

upright Middle

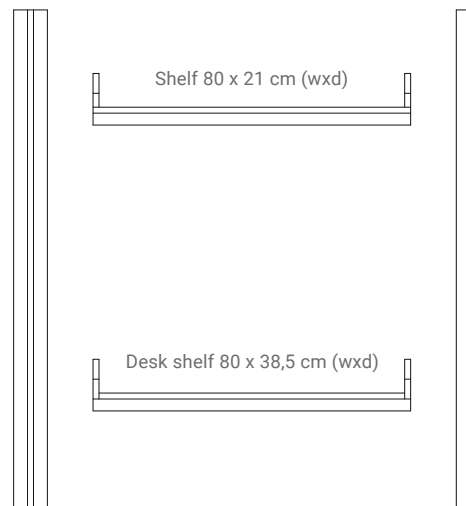

upright Right

OLE shelving system uprights

design: Studio Slow, 2024

prices 2024 in euro excl. VAT

no customization possible

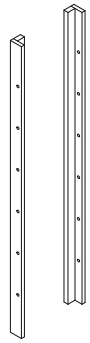

dimensions

Ole upright set Left + Right

Hight 72 cm

Hight 90 cm

Hight 126 cm

Hight 180 cm

Ole upright Middle

Hight 72 cm

Hight 90 cm

Hight 126 cm

Hight 180 cm

beech

light elm

oak

walnut

key features / additional prices

- base = upright set Left + Right
- available in 4 heights (72/90/126/180)
the height is a multiple of 18 cm,
the hole distance is 18 cm
- the space that each upright takes up is
1.5 cm, this applies to Left, Right and
the Middle Upright
- Uprights Left and Right are 50mm wide
and 55mm deep
- Upright Middle = 85mm wide
and 55mm deep
- finishing options according to the
solid wood samples as presented
in a current sample box
- prices are the same for all finishes with
soap/oil/lacquer/stain lacquer/coloured
lacquer

360

400

414

476

214

242

255

294

396

440

456

524

235

266

281

323

434

484

502

576

259

292

309

356

OLE shelving system compartments 60cm

design: Studio Slow, 2024

prices 2024 in euro excl. VAT

no customization possible

dimensions

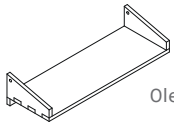

Ole shelf 60 x depth 21cm

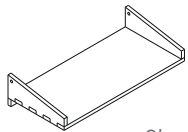

Ole shelf 60 x depth 28 cm

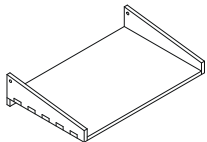

Ole desk shelf
60 x depth 38,5 cm

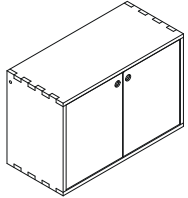

Ole cabinet
module
60 cm wide
40 cm high
28 cm depth

beech

light elm

oak

walnut

key features / additional prices

264

290

319

295

324

357

303

334

367

975

1.072

1.179

- An Ole cabinet module has 1 adjustable shelf
- finishing options according to the solid wood samples as presented in a current sample box
- prices are the same for all finishes with soap/oil/lacquer/stain lacquer/coloured lacquer

OLE shelving system compartments 80cm

design: Studio Slow, 2024

prices 2024 in euro excl. VAT

no customization possible

dimensions

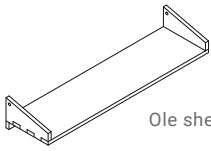

Ole shelf 80 x depth 21cm

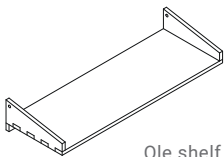

Ole shelf 80 x depth 28 cm

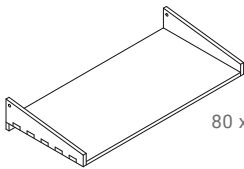

Ole desk shelf
80 x depth 38,5 cm

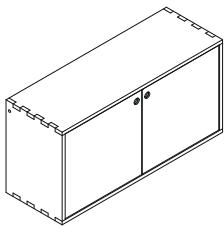

Ole cabinet
module
80 cm wide
40 cm high
28 cm depth

beech	oak	walnut
-------	-----	--------

light elm

278

oak

305

walnut

336

315

347

382

348

383

421

1.162

1.278

1.406

key features / additional prices

- An Ole cabinet module has 1 adjustable shelf
- finishing options according to the solid wood samples as presented in a current sample box
- prices are the same for all finishes with soap/oil/lacquer/stain lacquer/coloured lacquer

OLE shelving system examples

design: Studio Slow, 2024

prices 2024 in euro excl. VAT

no customization possible

dimensions

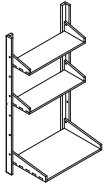

EXAMPLE 1

extra workspace 60cm

total dimensions 630 x 405 x 1260

To order:

- a. 1 set of uprights L+R height 126cm
- b. 2x shelf 60cm wide, 21cm deep
- c. 1x work shelf 60cm wide, 38.5cm deep

beech
light elm

1x 414 = 414
2x 264 = 528
1x 303 = 303

TOTAL
1.245

oak

1x 456 = 456
2x 290 = 580
1x 334 = 334

TOTAL
1.370

walnut

1x 501 = 501
2x 319 = 638
1x 367 = 367

TOTAL
1.506

key features / additional prices

- On this and the next page some price examples including order formulation are shown.
- finishing options according to the solid wood samples as presented in a current sample box
- prices are the same for all finishes with soap/oil/lacquer/stain lacquer/coloured lacquer
- for a proper processing of an order, in addition to the selected wood type and finish, we need the following information:
 1. height measurement of uprights (72/90/126/180)
 2. number of middle uprights
 3. number of shelves in desired width (60/80) + desired depth (21/28/38.5)
 4. number of cabinet modules + width (60/80)
 5. An order is accompanied by a clear sketch.

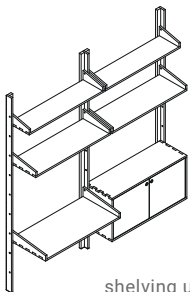

EXAMPLE 2

shelving unit + workspace 80cm

total dimensions 1645 x 405 x 1800

To order:

- a. 1 set of uprights L+R height 180cm
- b. 1 middle upright, height 180cm
- c. 2x shelf 80cm wide, 21cm deep
- d. 2x shelf 80cm wide, 28cm deep
- e. 1x work shelf 80cm wide, 38.5cm deep
- f. 1x cabinet module, width 80cm

1x 476 = 476
1x 294 = 294
2x 278 = 556
2x 315 = 630
1x 348 = 348
1x 1162 = 1162

TOTAL
3.466

1x 524 = 524
1x 323 = 323
2x 305 = 610
2x 347 = 694
1x 383 = 383
1x 1278 = 1278

TOTAL
3.812

1x 576 = 576
1x 356 = 356
2x 336 = 672
2x 382 = 764
1x 421 = 421
1x 1406 = 1406

TOTAL
4.195

OLE shelving system examples

design: Studio Slow, 2024

prices 2024 in euro excl. VAT

no customization possible

dimensions

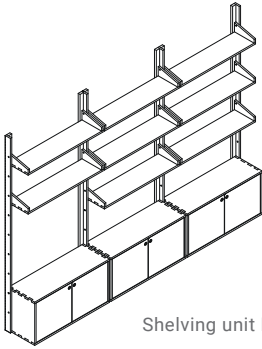

EXAMPLE 3

Shelving unit Medium 80cm

total dimensions 2460 x 405 x 1800

To order:

- a. 1 set of uprights L+R height 180cm
- b. 2x middle uprights, height 180cm
- c. 8x shelf 80cm wide, 21cm deep
- d. 3x cabinet module, width 80cm

beech

light elm

oak

walnut

1x 476 = 476	1x 524 = 524	1x 576 = 576
2x 294 = 588	2x 323 = 646	2x 356 = 712
8x 278 = 2224	8x 305 = 2440	8x 336 = 2688
3x 1162 = 3486	3x 1278 = 3834	3x 1406 = 4218
TOTAL	TOTAL	TOTAL
6.774	7.444	8.194

key features / additional prices

- finishing options according to the solid wood samples as presented in a current sample box
- prices are the same for all finishes with soap/oil/lacquer/stain lacquer/coloured lacquer
- for a proper processing of an order, in addition to the selected wood type and finish, we need the following information:
 1. height measurement of uprights (72/90/126/180)
 2. number of middle uprights
 3. number of shelves in desired width (60/80) + desired depth (21/28/38.5)
 4. number of cabinet modules + width (60/80)
 5. An order is accompanied by a clear sketch.

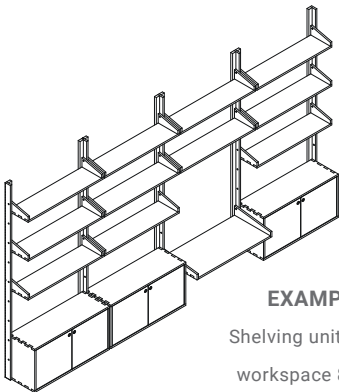

EXAMPLE 4

Shelving unit XL + workspace 80cm

total dimensions 3275 x 405 x 1800

To order:

- a. 1 set of uprights L+R height 180cm
- b. 3x middle uprights, height 180cm
- c. 11x shelf 80cm wide, 21cm deep
- d. 1x work shelf 80cm wide, 38.5cm deep
- e. 3x cabinet module, width 80cm

1x 476 = 476	1x 524 = 524	1x 576 = 576
3x 294 = 882	3x 323 = 969	3x 356 = 1068
11x 278 = 3058	11x 305 = 3355	11x 336 = 3696
1x 348 = 348	1x 383 = 383	1x 421 = 421
3x 1162 = 3486	3x 1278 = 3834	3x 1406 = 4218
TOTAL	TOTAL	TOTAL
8.250	9.065	9.979

0208 SYM cabinet

design: Gjalt Pilat, 2002

prices 2024 in euro excl. VAT

custom sizes on request

dimensions

0208 SYM cabinet



W x D x H

80 x 47 x 100

solid wood body

MDF body:

RAL/Sikkens color

light elm

2.206

1.714

oak

2.427

1.886

walnut

2.669

2.075

key features / additional prices

- doors have an damping effect when closing
- body is dismountable
- cabinet is supplied assembled unless otherwise ordered
- hull is either all solid wood or MDF in RAL or Sikkens color of your choice
- shelves are not height adjustable
- number of shelves at a height of:
100 cm: 2 / 140 cm: 3 / 220 cm: 4
- The finishing options are according to the solid wood samples such as presented in the current sample box.
- The prices are the same for all finishes; soap and / or oil, stain-lacquer, transparent lacquer and color lacquer.

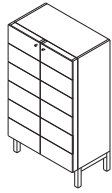

80 x 47 x 140

solid wood body

MDF body:

RAL/Sikkens color

3.003

2.348

3.303

2.583

3.633

2.841

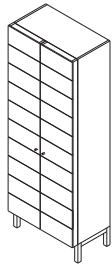

80 x 47 x 220

solid wood body

MDF body:

RAL/Sikkens color

4.032

3.256

4.436

3.581

4.879

3.939

- The information and prices in this price list have been compiled with great care. Despite this care, you may encounter printing and typing errors. We accept no liability for such errors. All information in this price list is therefore subject to printing and typing errors.

PILAT & PILAT

SHOWROOM NL

PILAT&PILAT

Tsjerkebuorren 40

9286 GC Twijzel

+31(0)511 543 981

pilat@pilat.nl

WWW.PILAT.NL