

OLE shelving system

design: Studio Slow, 2024

prices 2024 in euro excl. VAT

no customization possible

example configuration

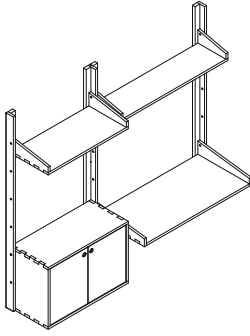

Basic components
OLE shelving system
using the example
shown above

beech
light elm
oak
walnut

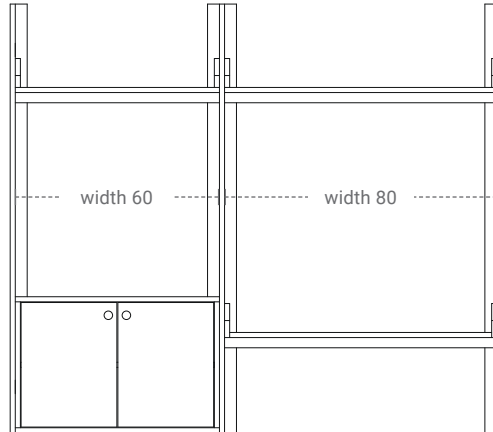

key features / additional prices

- To build an Ole shelving unit, 3 types of compartments are available; uprights, shelves and cabinets.
- Upright lengths 72 / 90 / 126 / 180 cm.
- Shelf widths 60 / 80 cm, available in depths 21 / 28 / 38.5 cm.
- Cabinet module widths 60 / 80 cm, depth 28 cm.
- Dimensions and prices of the different parts are made clear on the next 5 pages
- finishing options according to the solid wood samples as presented in a current sample box
- prices are the same for all finishes with soap/oil/lacquer/stain lacquer/coloured lacquer

when ordering

- for a proper processing of an order, in addition to the selected wood type and finish, we need the following information:
 1. height measurement of uprights (72/90/126/180)
 2. number of middle uprights
 3. number of shelves in desired width (60/80) + desired depth (21/28/38.5)
 4. number of cabinet modules + width (60/80)
 5. An order is accompanied by a clear sketch.

upright Left

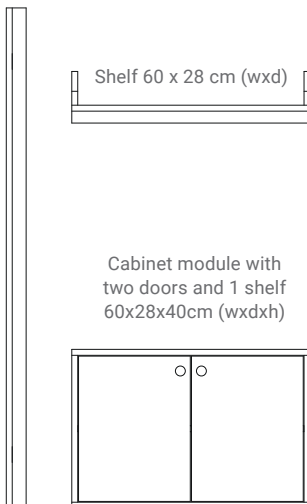

upright Middle

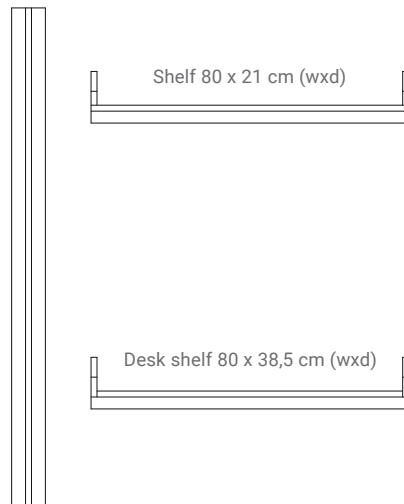

upright Right



OLE shelving system uprights

design: Studio Slow, 2024

prices 2024 in euro excl. VAT

no customization possible

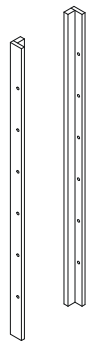

dimensions

Ole upright set Left + Right

Hight 72 cm
Hight 90 cm
Hight 126 cm
Hight 180 cm

Ole upright Middle

Hight 72 cm
Hight 90 cm
Hight 126 cm
Hight 180 cm

beech
light elm **oak** **walnut**

360	396	434
400	440	484
414	456	502
476	524	576
214	235	259
242	266	292
255	281	309
294	323	356

key features / additional prices

- base = upright set Left + Right
- available in 4 heights (72/90/126/180) the height is a multiple of 18 cm, the hole distance is 18 cm
- the space that each upright takes up is 1.5 cm, this applies to Left, Right and the Middle Upright
- Uprights Left and Right are 50mm wide and 55mm deep
- Upright Middle = 85mm wide and 55mm deep
- finishing options according to the solid wood samples as presented in a current sample box
- prices are the same for all finishes with soap/oil/lacquer/stain lacquer/coloured lacquer

OLE shelving system compartments 60cm

design: Studio Slow, 2024

prices 2024 in euro excl. VAT

no customization possible

dimensions

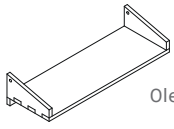

Ole shelf 60 x depth 21cm

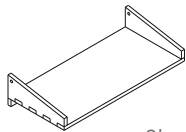

Ole shelf 60 x depth 28 cm

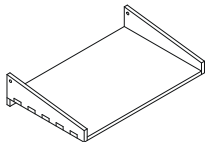

Ole desk shelf
60 x depth 38,5 cm

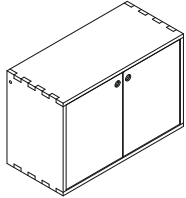

Ole cabinet
module
60 cm wide
40 cm high
28 cm depth

beech
light elm

oak

walnut

key features / additional prices

264

290

319

295

324

357

303

334

367

975

1.072

1.179

- An Ole cabinet module has 1 adjustable shelf
- finishing options according to the solid wood samples as presented in a current sample box
- prices are the same for all finishes with soap/oil/lacquer/stain lacquer/coloured lacquer

OLE shelving system compartments 80cm

design: Studio Slow, 2024

prices 2024 in euro excl. VAT

no customization possible

dimensions

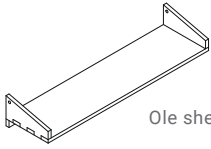

Ole shelf 80 x depth 21cm

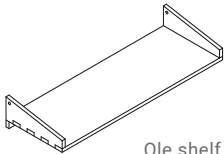

Ole shelf 80 x depth 28 cm

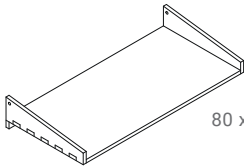

Ole desk shelf
80 x depth 38,5 cm

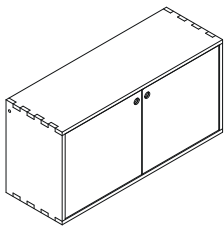

Ole cabinet
module
80 cm wide
40 cm high
28 cm depth

beech

light elm

oak

walnut

key features / additional prices

278

305

336

- An Ole cabinet module has 1 adjustable shelf
- finishing options according to the solid wood samples as presented in a current sample box
- prices are the same for all finishes with soap/oil/lacquer/stain lacquer/coloured lacquer

315

347

382

348

383

421

1.162

1.278

1.406

OLE shelving system examples

design: Studio Slow, 2024

prices 2024 in euro excl. VAT

no customization possible

dimensions

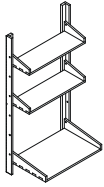

EXAMPLE 1

extra workspace 60cm

total dimensions 630 x 405 x 1260

To order:

- a. 1 set of uprights L+R height 126cm
- b. 2x shelf 60cm wide, 21cm deep
- c. 1x work shelf 60cm wide, 38.5cm deep

beech

light elm

oak

walnut

key features / additional prices

- On this and the next page some price examples including order formulation are shown.
- finishing options according to the solid wood samples as presented in a current sample box
- prices are the same for all finishes with soap/oil/lacquer/stain lacquer/coloured lacquer
- for a proper processing of an order, in addition to the selected wood type and finish, we need the following information:
 1. height measurement of uprights (72/90/126/180)
 2. number of middle uprights
 3. number of shelves in desired width (60/80) + desired depth (21/28/38.5)
 4. number of cabinet modules + width (60/80)
 5. An order is accompanied by a clear sketch.

1x 414 = 414

1x 456 = 456

1x 501 = 501

2x 264 = 528

2x 290 = 580

2x 319 = 638

1x 303 = 303

1x 334 = 334

1x 367 = 367

TOTAL

TOTAL

TOTAL

1.245

1.370

1.506

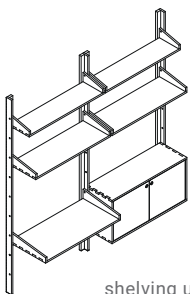

EXAMPLE 2

shelving unit + workspace 80cm

total dimensions 1645 x 405 x 1800

To order:

- a. 1 set of uprights L+R height 180cm
- b. 1 middle upright, height 180cm
- c. 2x shelf 80cm wide, 21cm deep
- d. 2x shelf 80cm wide, 28cm deep
- e. 1x work shelf 80cm wide, 38.5cm deep
- f. 1x cabinet module, width 80cm

1x 476 = 476

1x 524 = 524

1x 576 = 576

1x 294 = 294

1x 323 = 323

1x 356 = 356

2x 278 = 556

2x 305 = 610

2x 336 = 672

2x 315 = 630

2x 347 = 694

2x 382 = 764

1x 348 = 348

1x 383 = 383

1x 421 = 421

1x 1162 = 1162

1x 1278 = 1278

1x 1406 = 1406

TOTAL

TOTAL

TOTAL

3.466

3.812

4.195

OLE shelving system examples

design: Studio Slow, 2024

prices 2024 in euro excl. VAT

no customization possible

dimensions

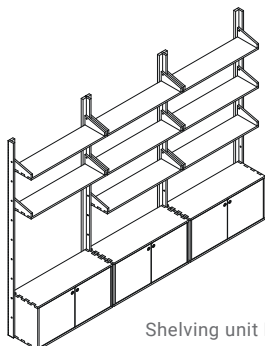

EXAMPLE 3

Shelving unit Medium 80cm

total dimensions 2460 x 405 x 1800

To order:

- a. 1 set of uprights L+R height 180cm
- b. 2x middle uprights, height 180cm
- c. 8x shelf 80cm wide, 21cm deep
- d. 3x cabinet module, width 80cm

beech	oak	walnut
light elm		
1x 476 = 476	1x 524 = 524	1x 576 = 576
2x 294 = 588	2x 323 = 646	2x 356 = 712
8x 278 = 2224	8x 305 = 2440	8x 336 = 2688
3x 1162 = 3486	3x 1278 = 3834	3x 1406 = 4218
TOTAL	TOTAL	TOTAL
6.774	7.444	8.194

key features / additional prices

- finishing options according to the solid wood samples as presented in a current sample box
- prices are the same for all finishes with soap/oil/lacquer/stain lacquer/coloured lacquer
- for a proper processing of an order, in addition to the selected wood type and finish, we need the following information:
 1. height measurement of uprights (72/90/126/180)
 2. number of middle uprights
 3. number of shelves in desired width (60/80) + desired depth (21/28/38.5)
 4. number of cabinet modules + width (60/80)
 5. An order is accompanied by a clear sketch.

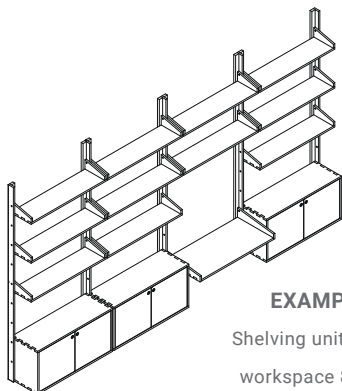

EXAMPLE 4

Shelving unit XL + workspace 80cm

total dimensions 3275 x 405 x 1800

To order:

- a. 1 set of uprights L+R height 180cm
- b. 3x middle uprights, height 180cm
- c. 11x shelf 80cm wide, 21cm deep
- d. 1x work shelf 80cm wide, 38.5cm deep
- e. 3x cabinet module, width 80cm

1x 476 = 476	1x 524 = 524	1x 576 = 576
3x 294 = 882	3x 323 = 969	3x 356 = 1068
11x 278 = 3058	11x 305 = 3355	11x 336 = 3696
1x 348 = 348	1x 383 = 383	1x 421 = 421
3x 1162 = 3486	3x 1278 = 3834	3x 1406 = 4218
TOTAL	TOTAL	TOTAL
8.250	9.065	9.979